

DATA SHEET



BAS32L High-speed diode

Product specification
Supersedes data of April 1996

1996 Sep 10

High-speed diode

BAS32L

FEATURES

- Small hermetically sealed glass SMD package
- High switching speed: max. 4 ns
- Continuous reverse voltage: max. 75 V
- Repetitive peak reverse voltage: max. 75 V
- Repetitive peak forward current: max. 450 mA.

APPLICATIONS

- High-speed switching
- Fast logic applications.

DESCRIPTION

The BAS32L is a high-speed switching diode fabricated in planar technology, and encapsulated in the small hermetically sealed glass SOD80C SMD package.

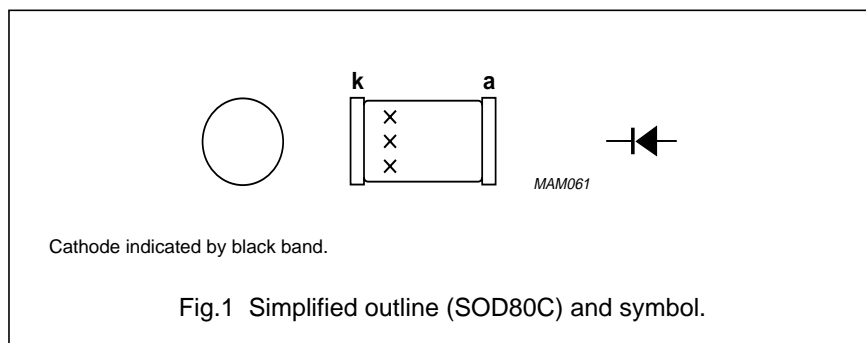

LIMITING VALUES

In accordance with the Absolute Maximum Rating System (IEC 134).

SYMBOL	PARAMETER	CONDITIONS	MIN.	MAX.	UNIT
V _R	continuous reverse voltage		–	75	V
V _{RRM}	repetitive peak reverse voltage		–	75	V
I _F	continuous forward current	see Fig.2; note 1	–	200	mA
I _{FRM}	repetitive peak forward current		–	450	mA
I _{FSM}	non-repetitive peak forward current	square wave; T _j = 25 °C prior to surge; see Fig.4			
		t = 1 μs	–	4	A
		t = 1 ms	–	1	A
		t = 1 s	–	0.5	A
P _{tot}	total power dissipation	T _{amb} = 25 °C; note 1	–	500	mW
T _{stg}	storage temperature		–65	+200	°C
T _j	junction temperature		–	200	°C

Note

1. Device mounted on an FR4 printed-circuit board.

High-speed diode

BAS32L

ELECTRICAL CHARACTERISTICS

$T_j = 25\text{ °C}$; unless otherwise specified.

SYMBOL	PARAMETER	CONDITIONS	MIN.	MAX.	UNIT
V_F	forward voltage	see Fig.3 $I_F = 5\text{ mA}$	620	750	mV
		$I_F = 100\text{ mA}$	–	1000	mV
		$I_F = 100\text{ mA}; T_j = 100\text{ °C}$	–	930	mV
I_R	reverse current	see Fig.5 $V_R = 20\text{ V}$	–	25	nA
		$V_R = 75\text{ V}$	–	5	μA
		$V_R = 20\text{ V}; T_j = 150\text{ °C}$	–	50	μA
		$V_R = 75\text{ V}; T_j = 150\text{ °C}$	–	100	μA
$V_{(BR)R}$	reverse breakdown voltage	$I_R = 100\text{ }\mu\text{A}$	100	–	V
C_d	diode capacitance	$f = 1\text{ MHz}; V_R = 0$; see Fig.6		2	pF
t_{rr}	reverse recovery time	when switched from $I_F = 10\text{ mA}$ to $I_R = 10\text{ mA}; R_L = 100\text{ }\Omega$; measured at $I_R = 1\text{ mA}$; see Fig.7		4	ns
V_{fr}	forward recovery voltage	when switched from $I_F = 50\text{ mA}$; $t_r = 20\text{ ns}$; see Fig.8	–	2.5	V

THERMAL CHARACTERISTICS

SYMBOL	PARAMETER	CONDITIONS	VALUE	UNIT
$R_{th\ j-tp}$	thermal resistance from junction to tie-point		300	K/W
$R_{th\ j-a}$	thermal resistance from junction to ambient	note 1	350	K/W

Note

1. Device mounted on an FR4 printed-circuit board.

High-speed diode

BAS32L

GRAPHICAL DATA

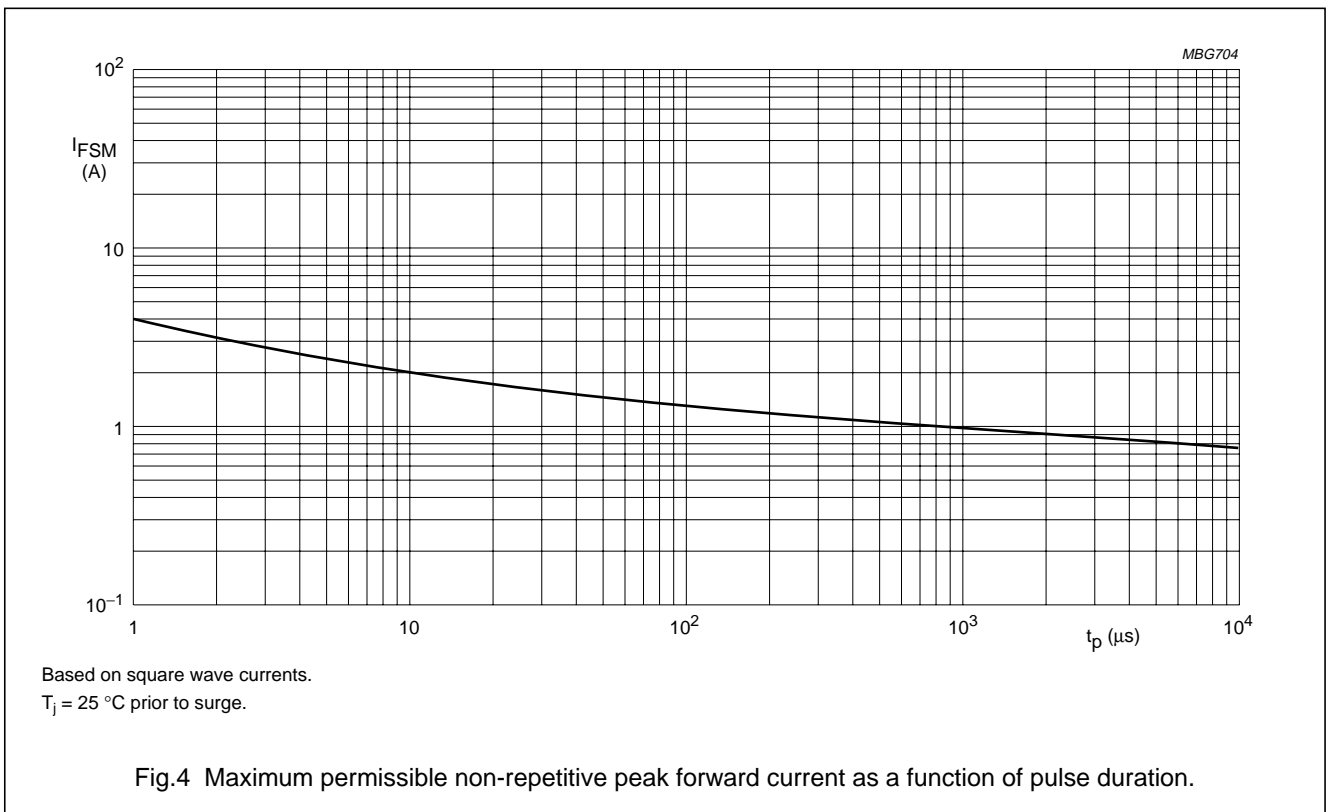
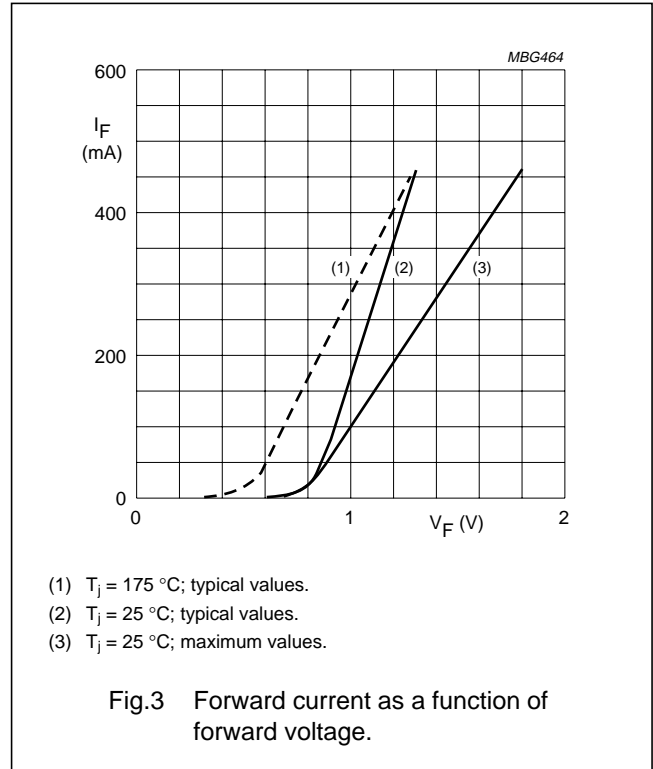
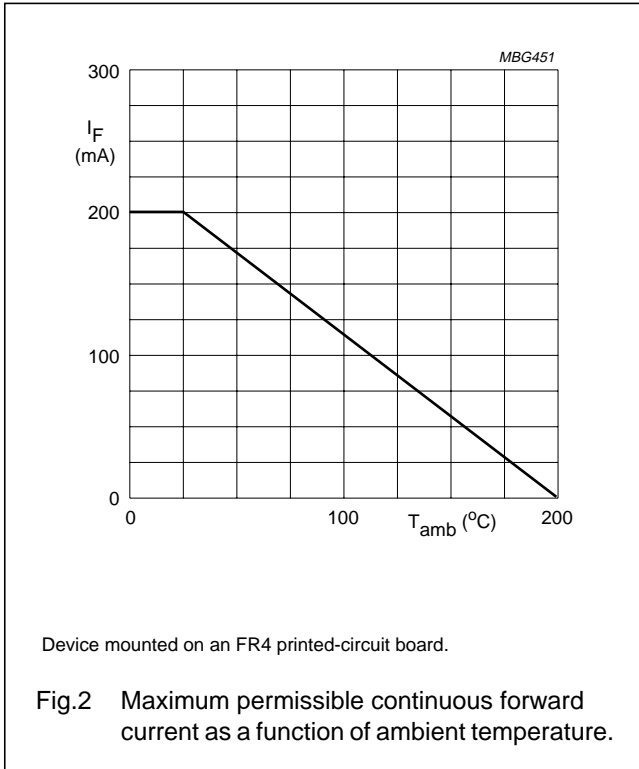

High-speed diode

BAS32L

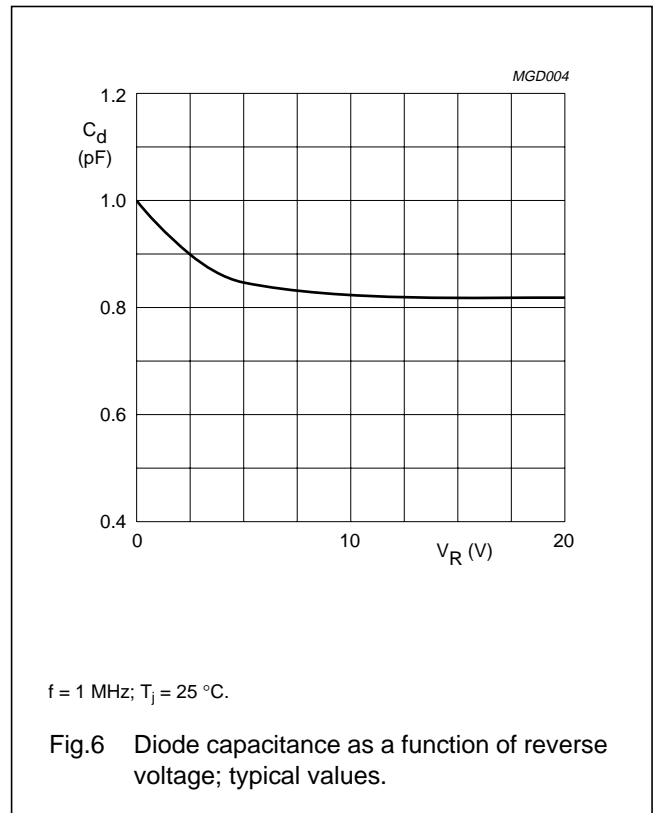
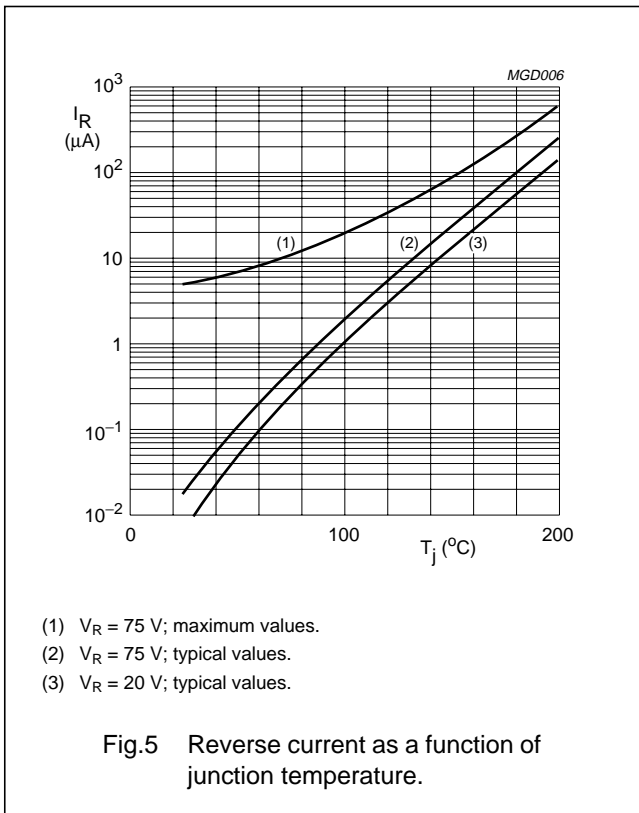

High-speed diode

BAS32L

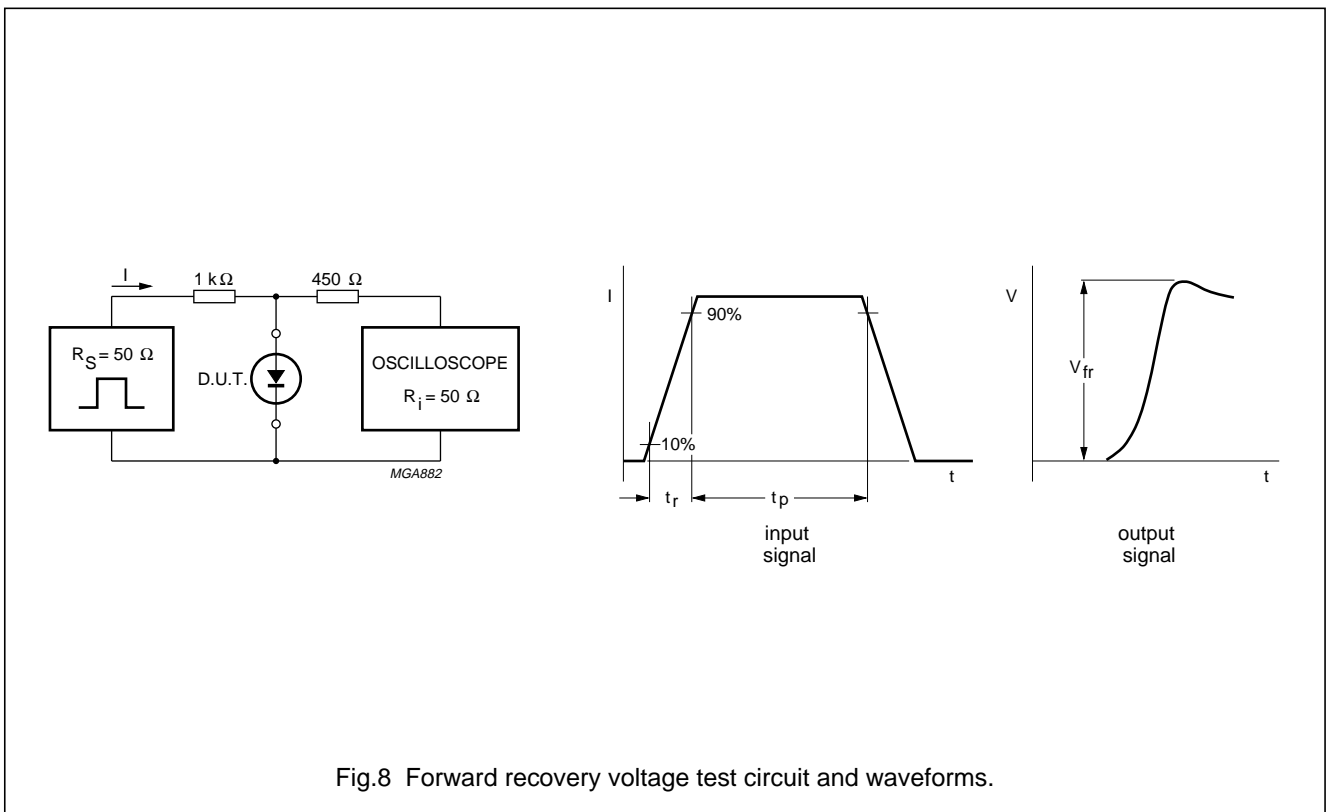
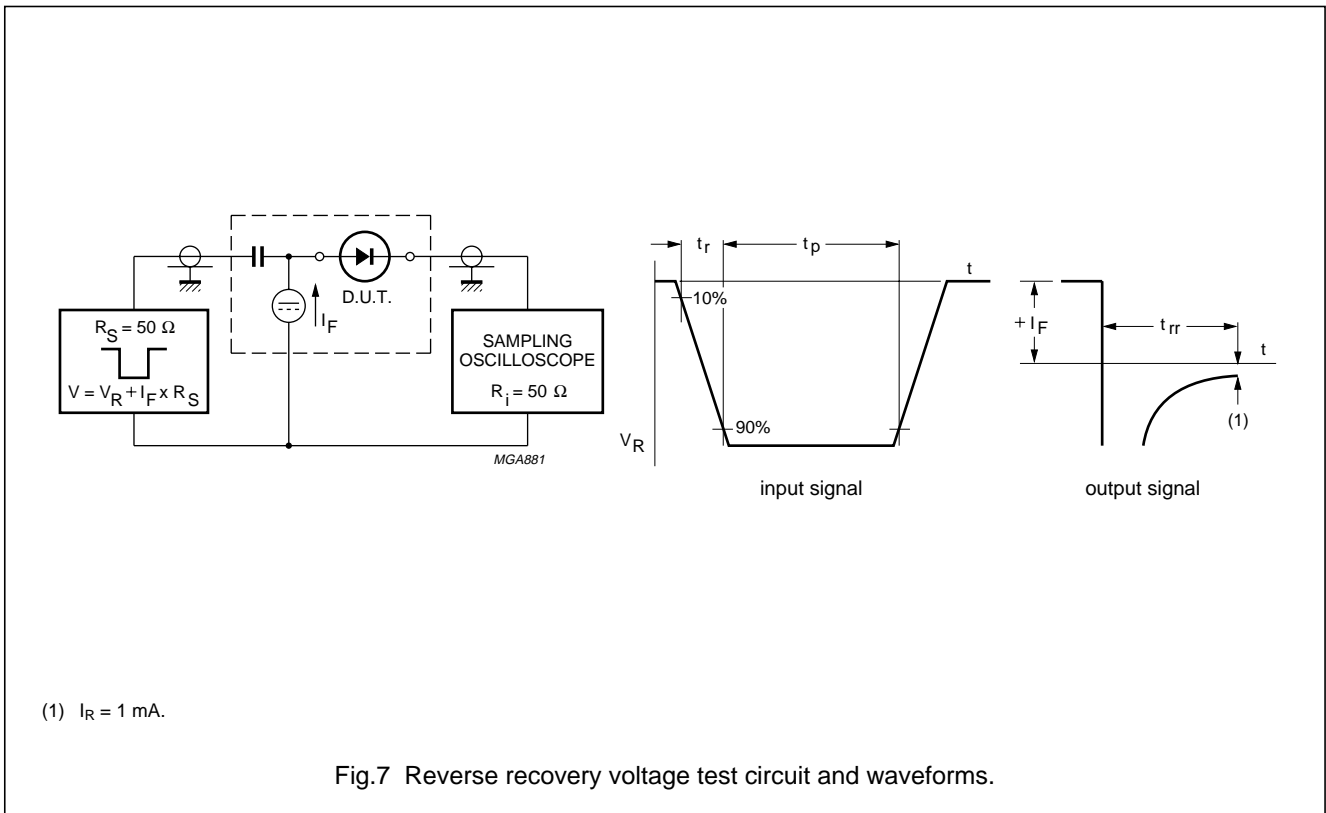

High-speed diode

BAS32L

PACKAGE OUTLINE

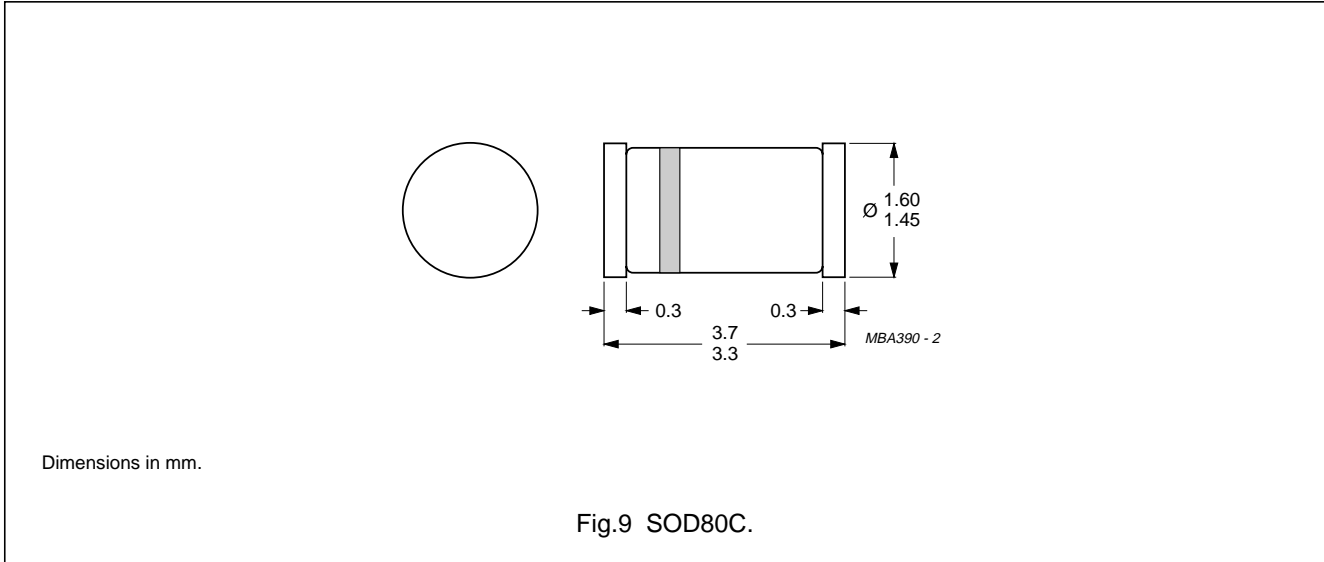

DEFINITIONS

Data Sheet Status	
Objective specification	This data sheet contains target or goal specifications for product development.
Preliminary specification	This data sheet contains preliminary data; supplementary data may be published later.
Product specification	This data sheet contains final product specifications.
Limiting values	
Limiting values given are in accordance with the Absolute Maximum Rating System (IEC 134). Stress above one or more of the limiting values may cause permanent damage to the device. These are stress ratings only and operation of the device at these or at any other conditions above those given in the Characteristics sections of the specification is not implied. Exposure to limiting values for extended periods may affect device reliability.	
Application information	
Where application information is given, it is advisory and does not form part of the specification.	

LIFE SUPPORT APPLICATIONS

These products are not designed for use in life support appliances, devices, or systems where malfunction of these products can reasonably be expected to result in personal injury. Philips customers using or selling these products for use in such applications do so at their own risk and agree to fully indemnify Philips for any damages resulting from such improper use or sale.