

Digital Indicating Controller



ISO9001 Certified
JQA - 2055



Faster and Smarter Control



FCD series



Shinko

FC series is...

FC series is the high performance and low price Controllers for single loop, applicable to various process controls as well as temperature control.

Development concepts

- Improvement in basic performances
- Easy-to-use by Simple operations
- Extended the strong point of PID control and compensated the weak point.
- Cost reduced by simple design.



Quick response

Basic performances such as the processing speed of operation, the Input and output resolution and the Input and output accuracy are improved by making the built-in computer to high performance. The speed of response is realized 135ms or less in case PV filter function (*1) and External setting function (*2) do not work with Current output type (*3).

(*1): When the PV filter function is used, the speed of response becomes slow.

(*2): In case the option External setting is applied, the Input sampling period is changed to 500ms (-15A type: 250ms, Standard: 125ms).
In case the option Heater burnout alarm is applied, the Input sampling period is also changed to 500ms (FCS-100 series: 250ms).

(*3): The speed of response for excepting Current output type, it follows the setting value of the proportional cycle (control operating period).

Advanced control

1. Fuzzy self-tuning

Fuzzy self-tuning is a function to perform a fine adjustment of PID values automatically. The stable control can be carried out even if the conditions of the process is changed owing to such as various and variable production (*1).

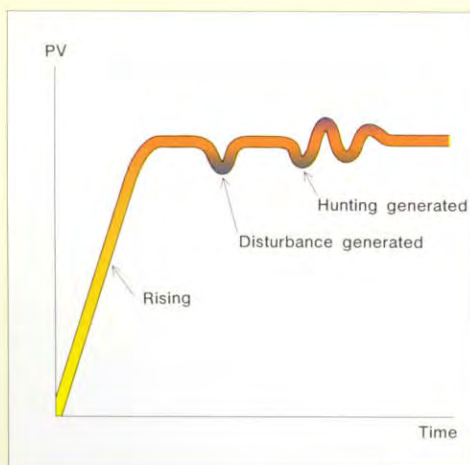

- (1) When the control is rising, the controller performs the control by the PID values tuned in advance (*2).
- (2) When disturbance is found, the controller checks the converging status, and performs the fine adjustment of PID values if necessary.
 - ① If the convergence is performed smoothly, the PID values are not changed.
 - ② If the convergent speed is slow, the controller corrects the PID values to make the convergence faster.
 - ③ When overshoot is generated during the convergence, the controller corrects the PID values to make the overshoot will not be generated.
 - ④ When hunting is generated, the controller checks the waveform and performs the fine adjustment of PID values.

(*1): The controller can be used without Fuzzy self-tuning by designating the internal switch.

(*2): Fuzzy self-tuning is a function to perform a fine adjustment of PID. When using the controller for the first time, perform the PID auto-tuning or set the proper PID values by key operations.

Application examples

The high-speed-fuzzy of FC series includes multiform applications for automatic controls.

Temperature control for various molding machinery

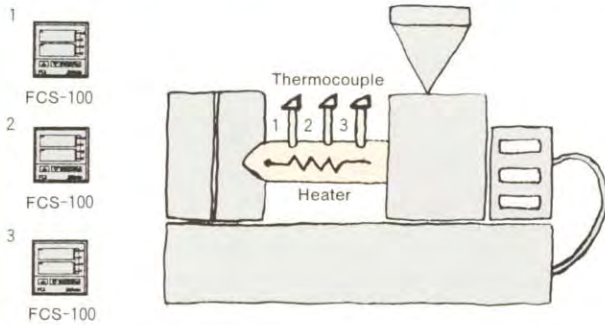

The quick transient response and the overshoot preventing function will lead effective manufacturing.

Temperature control for various electric furnaces

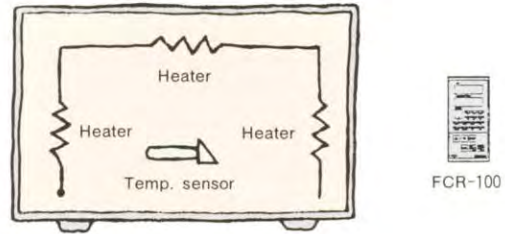

The high-speed-fuzzy and the multi-PID control will correspond to the various and variable manufacturing.

Flow rate control for the feed pipes

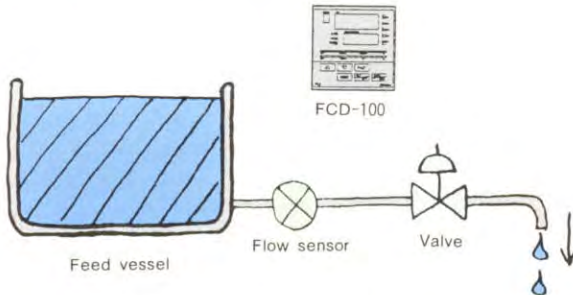

It operates by 125ms sampling period and controls the open/closed of the valve.

Temperature and humidity control for the thermo-hygrostats

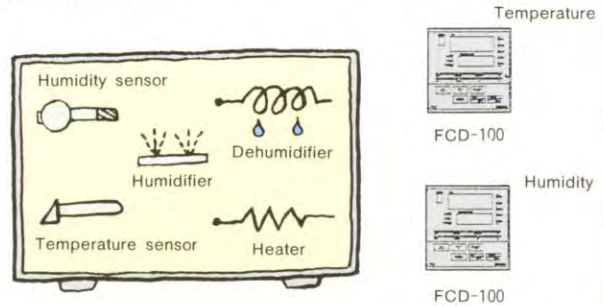

The cooling mode can be selected, and simplified program control can be performed.

Temperature control by non-contact system for film or cloth

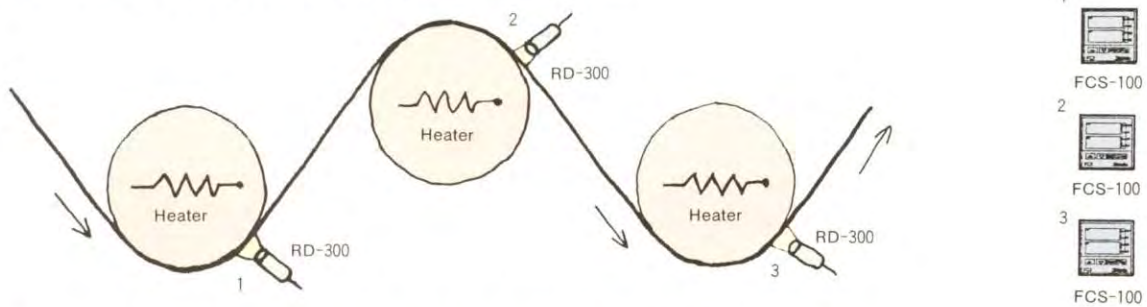

The quick response allows the controller to use the Infrared thermocouple, RD-300 series.

Temperature and humidity control for various cooking machines

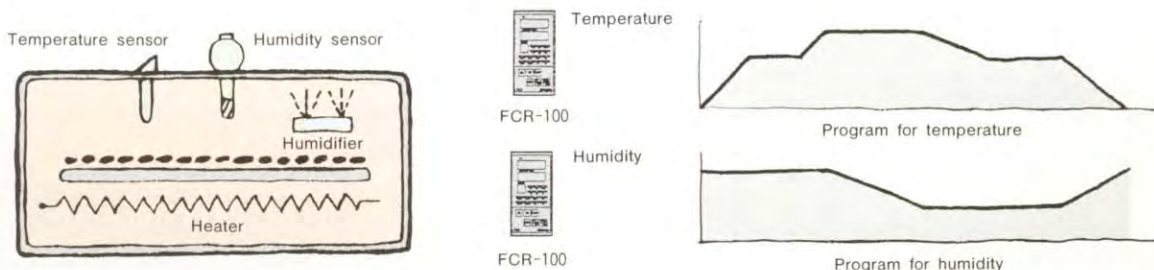

By programming the appropriate temperature and humidity, the quality of flavor will be repeated.

Application examples

Types of controller are merely examples.

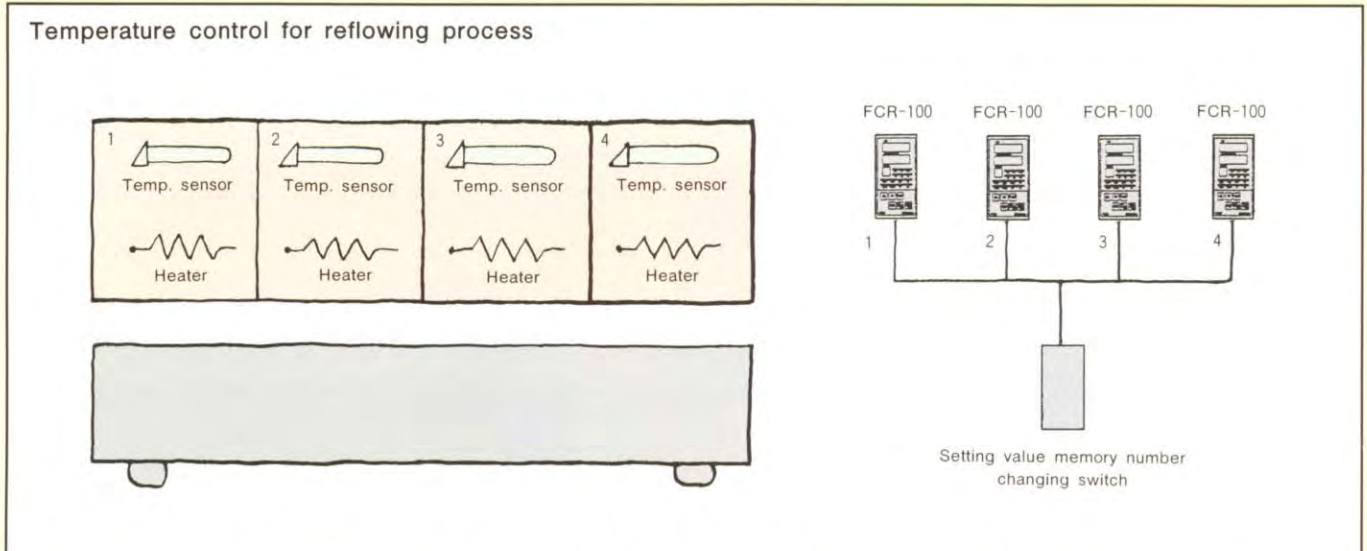

Setting value memory function allows the controller to carry out the multi-point control for versatile production easily.

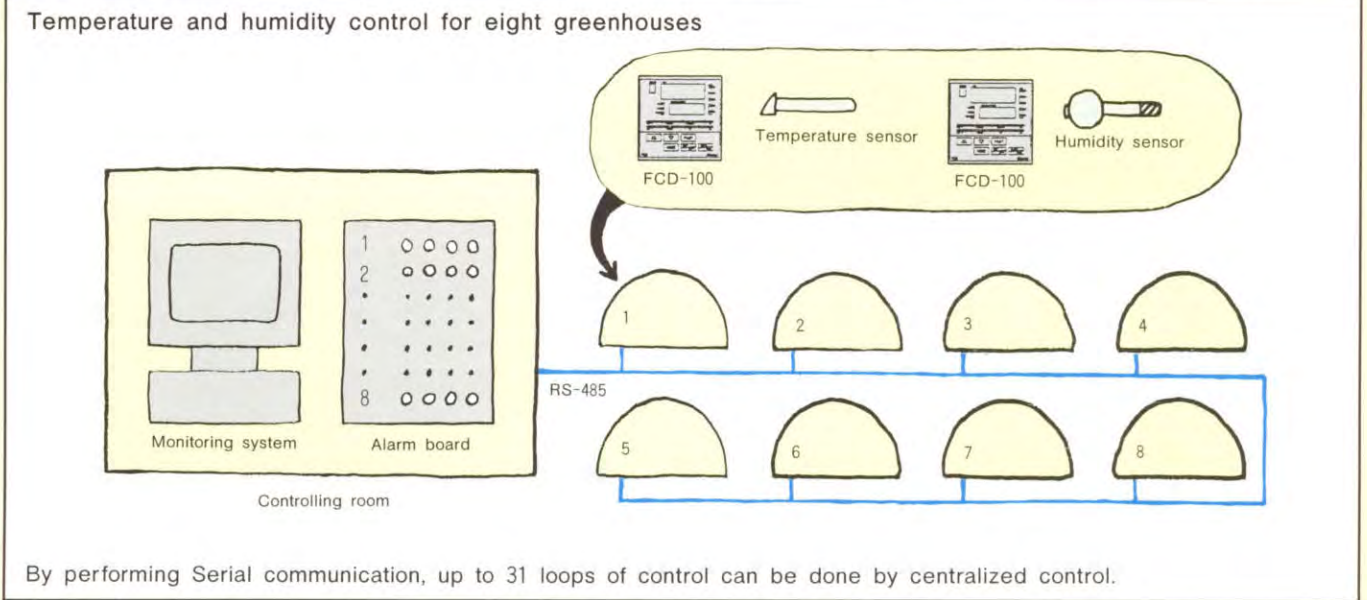

By performing Serial communication, up to 31 loops of control can be done by centralized control.

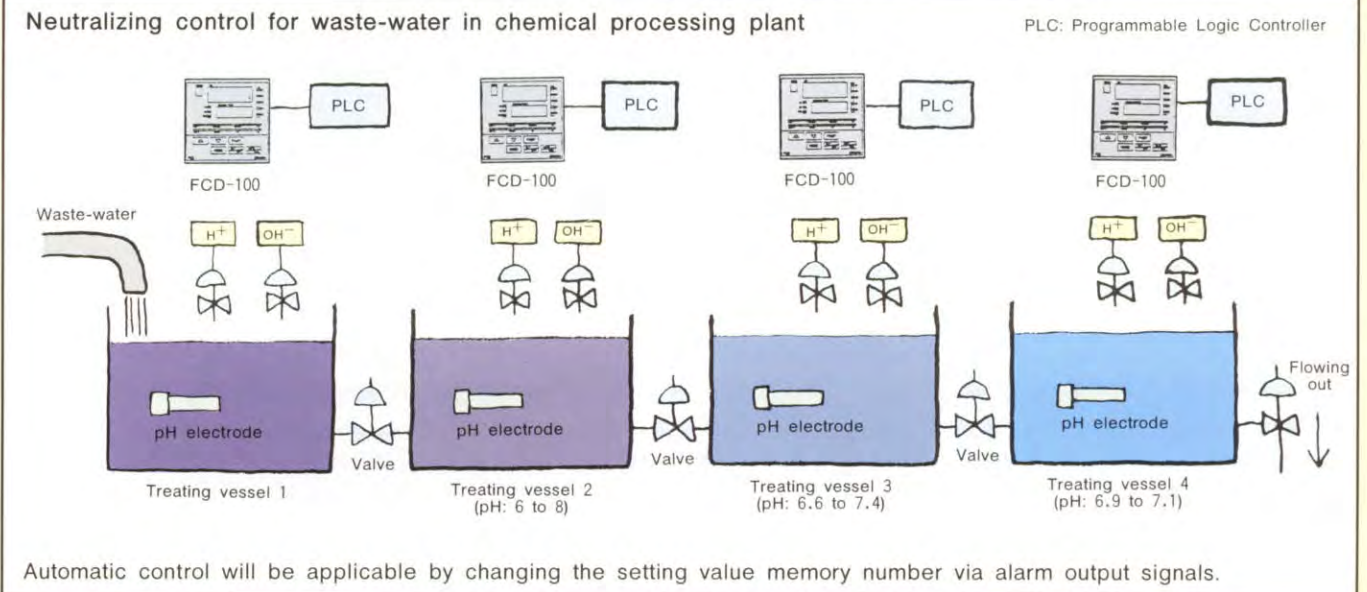

Automatic control will be applicable by changing the setting value memory number via alarm output signals.

Attached functions

FC series has several standard functions which make the best use of its basic performance, as follows.

Multi-function

Each specification can be set as you please.

Selector switches

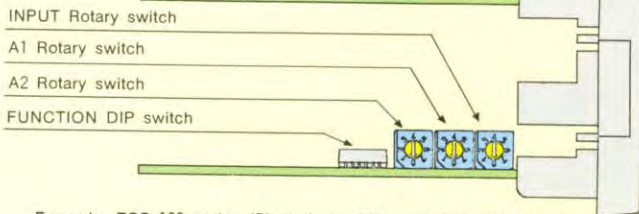

Example: FCS-100 series (Similarly to FCD and FCR-100 series)

[Drawing out]

1. Pinch the top and bottom hollows and push the bottom hook.

2. Giving a slight swing and pull out toward this side.

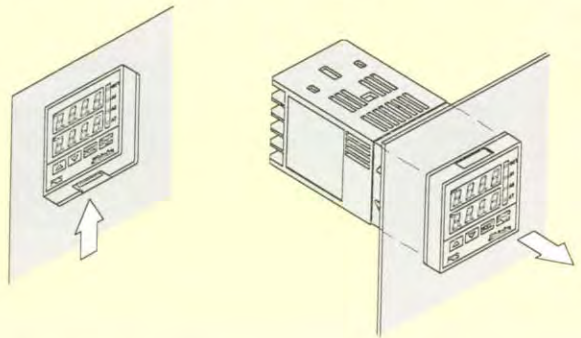

- ※ A2 Rotary switch is not provided, when Alarm 2 (option) is not applied.
- ※ Number of bit for FUNCTION DIP switch of the FCS-100 series is six (bit7 and bit8 are not available).

PV input type selection

By designation of INPUT Rotary switch and FUNCTION DIP switch bit7, PV input type can be selected from the following 16 types of input. When shipped, it is designated as thermocouple K.

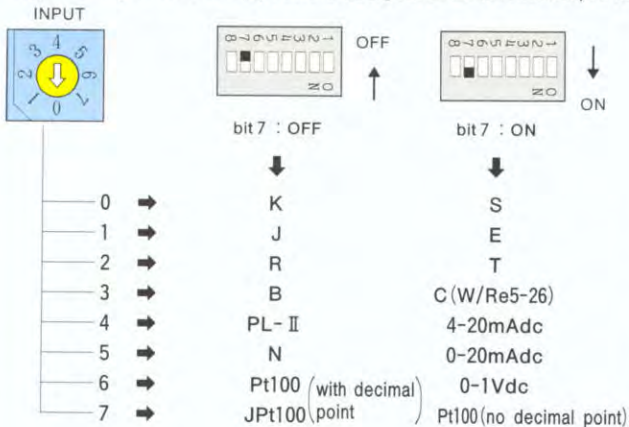

- ※ As to the FCS-100 series, the input type can be selected by INPUT rotary switch.
- The types of input are K, J, R, B, PL-II, N, Pt100 (w/decimal point) and JPt100 (w/decimal point).

Temperature unit switching

By designation of FUNCTION DIP switch bit6, the temperature unit can be selected. When shipped it is designated as °C.



- ※ When applied DC input type, the designation on °C or °F will be ineffectual.

Direct/Reverse action change

By designation of FUNCTION DIP switch bit3, either the direct output action or the reverse output action can be selected. When shipped it is designated as the reverse (heating).

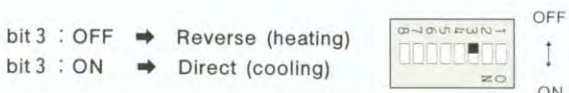

Control action selection

By designation of FUNCTION DIP switch bit1 and bit2, the control output type can be selected. When shipped it is designated as the fuzzy self-tuning PID.



- bit 1 : OFF, bit 2 : OFF → Fuzzy self-tuning PID
- bit 1 : ON, bit 2 : OFF → PID (non-self-tuning)
- bit 1 : OFF, bit 2 : ON → PD
- bit 1 : ON, bit 2 : ON → ON/OFF

Alarm 1 output action selection

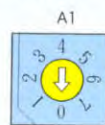

By designation of A1 Rotary switch, the output action of Alarm 1 can be selected. When shipped it is designated as no function.

- 0 → No function
- 1 → High limit action (Deviation setting)
- 2 → Low limit action (Deviation setting)
- 3 → High/Low limits action (Deviation setting)
- 4 → High/Low limit range action (Deviation setting)
- 5 → Process value high limit action
- 6 → Process value low limit action
- 7 → Pattern end output (for Simplified program control)

- ※ When applying the option Alarm 2, the Alarm 2 output action can be selected similarly by using A2 Rotary switch.

Alarm 1 standby-function selection

By designation of FUNCTION DIP switch bit4, the standby function existence of the Alarm 1 can be selected. When shipped it is designated as without function.

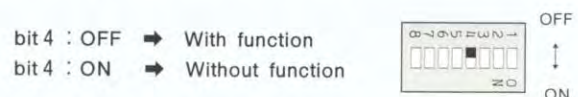

- ※ When applying the option Alarm 2, the Alarm 2 standby function can be selected similarly by using FUNCTION DIP switch bit5. When not applying Alarm 2, bit5 designation will be ineffectual.

Attached functions

Alarm (Alarm 1)

Alarm 1 acts ON/OFF, according to the following five items designation. The output signal is generated through open/closed of the relay contact.

1. Output action type

The output action type can be designated by A1 Rotary switch. It is selected as no alarm function when shipped.

2. Alarm acting point

Alarm acting point at which the alarm turns can be set by key operation. It should be set as the deviation value from the SV (when applied deviation setting), or as the process value (when applied process value setting).

3. Hysteresis

Hysteresis can be set as the deviation with the alarm acting point, by key operation. Once the alarm turns ON, the output is kept until the PV enters into the alarm OFF area.

4. Existence of standby function

In case with-standby-function is designated, when the power supply is turned ON or when the SV is changed, the alarm will not function, though the PV will be in the alarm ON area.

5. Alarm action delayed timer

When the PV enters into the alarm ON area, if ON-delayed acting time is set, the alarm remains OFF during the set time. The time can be set up to 60s (When shipped: 0s).

※ FCS-100 series does not have this function (The time cannot be set).

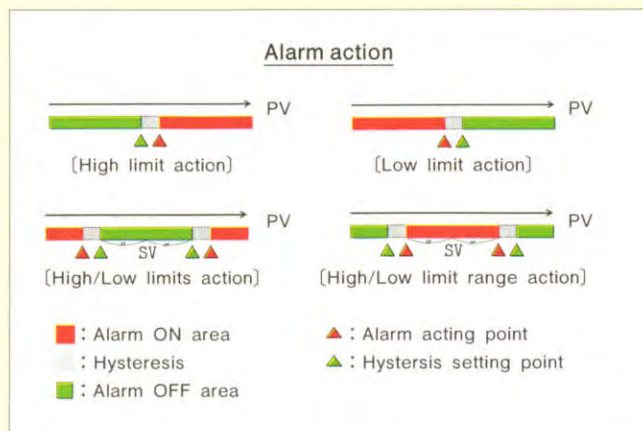

Setting value lock

It functions to prevent each setting value from careless change. The lock status can be selected by key operation from four types of status as follows.

- Lock free
 - All setting values lock [Lock mode 1]
 - All setting values lock except SV [Lock mode 2]
 - Non-volatile memory data lock [Lock mode 3]
- (Each setting value is changeable, but when the power is turned OFF, the changed values return to the values when Lock mode 3 was designated.)

Control output OFF

The control performing and stopping can be changed by one-touch key operation. When performing the simplified program control, this function works for RUN/STANDBY change.

Setting value memory (Simplified program controlling)

※ This function is not available to FCS-100 series.

The setting values on each file which includes SV, PID values and so on can be registered up to seven. The PID control or simplified program controlling can be performed by changing the setting values file number (setting value memory number).

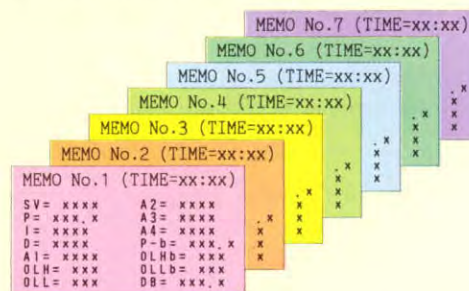

※ The above files include the setting items for the options.

There are three systems to change the setting value memory number (in case of Simplified program control, step number) as follows.

- Key operation
- External change (option, see page 9)
- In case of Simplified program control, the step number is changed by the time setting.

Others

● Sensor correction

If existing a constant deviation between the input PV and the true PV, the deviation can be corrected by shifting the input value (PV). (Correcting range: -100.0 to 100.0 [°C, °F])

● Setting value limit

It functions to limit the SV settable range within the setting value limit range.

● Setting value ramp

※ This function is not available to FCS-100 series.

SV-changing rate per minute can be restricted.

● Output limit

※ This function is not available to FCS-100 series.

MV-changing range can be restricted.

● Manual operation

※ This function is not available to FCS-100, 200 series.

Automatic control and manual control can be switched over by one-touch key operation (With balanceless bumpless function).

● PV filter

It functions to cut the high-frequency ingredient of the PV input signal. It is useful to strengthen against input noise, but on the other way it functions to make the controller slow on the controlling response. When shipped this function is cancelled.

● Burnout alarm

When the trouble is detected on the element such as thermocouple or RTD, it functions to make the control stop and tells of the trouble.

● Automatic cold junction temperature compensation

It detects temperature at the connecting terminals between thermocouple and instrument, and always makes it the same status at which the reference junction is located at 0°C.

● Self-diagnosis

When anything abnormal status is found on the CPU, it makes the controller warm-up status.

● Warm-up displays

When the power is turned ON, the applied PV input type is shown on the displays.

Optional functions

You can add only the options which are necessary for the application. When ordering, designate the applying option codes referring to the page 14 (FCD-100), the page 16 (FCR-100) or the page 18 (FCS-100, 200).

Heating and Cooling control

- ※ This option is not available to FCS-100, 200 series.
- ※ This option is not applicable when the control output type is ON/OFF servo.
- ※ This option cannot be added together with Alarm 2 or Loop break Alarm.

When adding this option, Control output 2 will be provided which can perform the Dual output control (Heating and Cooling control). When ordering, designate the control output type — Relay contact, Non-contact voltage or Current.

[Specifications]

- Control action of Control output 2 PID or ON/OFF
- Proportional band Multiplying factor 0.0 to 10.0 to the control output 1 (When set to 0.0, ON/OFF action)
- Integral time The same as the control output 1
- Derivative time The same as the control output 1
- Proportional cycle 1 to 120s (Not available for Current output type)
- Overlapband/Deadband \pm Proportional band span of the control output 1
- Hysteresis 0.1 to 100.0°C (°F)
- Control output To be designated when ordering from the followings
- Relay contact 1a
 - Resistive load: 3A (250Vac)
 - Inductive load: 1A (250Vac, $\cos\phi=0.4$)
 - Non-contact voltage For SSR drive 12^{+2} Vdc (40mA max.)
 - Current 4-20mAdc
 - Load resistance: 550Ω max.
- Cooling action mode Selectable by key operation from the following
- Air-cooling mode
 - The MV (manipulating valve) changes linear
 - Oil-cooling mode
 - The MV is the 1.5th power of the air-cooling mode
 - Water-cooling mode
 - The MV is the 2nd power of the air-cooling mode

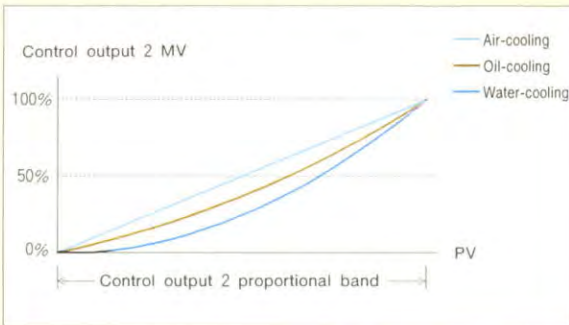

Alarm 2

- ※ This option cannot be added when the control output type is ON/OFF servo.
- ※ This option cannot be added together with Heating and Cooling control.

When adding this option, the number of alarms will increase by 1 (The standard number is 1).

[Specifications]

- Output action Selectable by A2 Rotary switch
- Standby function Selectable by FUNCTION DIP switch bit5
- Others The same as Alarm 1

Alarm 3, 4

- ※ This option is not available to FCR-100 and FCS-100, 200 series.

When adding this option, the number of alarms will increase by 2 (The standard number is 1).

[Specifications]

- Output action Selectable by key operation
- Standby function Selectable by key operation
- Others The same as Alarm 1

Heater burnout alarm

- ※ This option cannot be added when the control output type is Current.
- ※ This option is not applicable when the control output type is ON/OFF servo, and is not available to FCS-200 series, too.
- ※ 3-phase type of Heater burnout alarm is not available to the FCS-100 series, only single phase type is available.

When adding this option, it will be possible to detect the heater burnout by using the CT (current transformer). The heater burnout alarm acting point can be set as the current value (unit: 0.1A) which the alarm acts. Since the setting resolution has improved more than the former controllers, the FC series with the alarm which the CT input rating is 20A can detect heater burnout if the heater capacity is 5A or less.

- ※ In case this option is applied, PV input sampling period is changed to 500ms or 250ms (FCS-100 series).

[Specifications]

- CT input rating To be designated when ordering from the followings
- Single phase use, 20A
 - Single phase use, 50A
 - 3-phase use, 20A
 - 3-phase use, 50A
- Setting accuracy $\pm 5\%$ of the CT input rating
- Control output Relay contact 1a
- Control capacity Resistive load: 3A (250Vac)
Inductive load: 1A (250Vac, $\cos\phi=0.4$)
- Output self holding Not available
- Accessories CT (1 piece to Single phase type, 2 pieces to 3-phase type)

Loop break alarm

- ※ This option is not available to FCS-100 series.
- ※ This option cannot be added together with Heating and Cooling control.

The alarm will be output when the process variable (PV) does not rise as much value as the span or greater within the time to judge for loop break alarm after the manipulating value (MV) reaches to 100% or output high limit value.

The alarm will be also output when the PV does not fall as much value as the span or greater within the time to judge for loop break alarm after the MV reaches to 0% or output low limit value. When the control mode is Direct (Cooling), the alarm acts the opposite.

[Specifications]

- Loop break judging time 0 to 200 minute
- Loop break judging span 0.0 to 100.0°C (°F) or 0 to 1000
- Control output Relay contact 1a
- Control capacity Resistive load: 3A (250Vac)
Inductive load: 1A (250Vac, $\cos\phi=0.4$)

Optional functions

Transmission output

※ This option is not available to FCS-100, 200 series.

When adding this option, either PV, SV or MV will be transmitted as the analog signal. The output signal type is to be designated when ordering. The transmitting parameter type is selectable by key operation.

[Specifications]

Transmitting parameter PV, SV or MV (Selectable by key operation)
 Output signal To be designated when ordering from the followings
 • 4-20mA_{dc} (Load resistance: 550Ω max.)
 • 0-1V_{dc} (Load resistance: 100kΩ min.)
 Output accuracy Within ±0.3% of full scale

Setting value memory number external change

※ This option is not available to FCS-100, 200 series.

When adding this option, the setting value memory number will be selectable by changing the connections of terminal contacts.

※ We are separately selling the setting value memory number changing switch.

[Specifications]

Memory number changing system Switching the terminal connections

: open, : closed

Number	Connection		
	COM-b2	COM-b1	COM-b0
Key-designated number			
1			
2			
3			
4			
5			
6			
7			

Parallel connectable number Up to 48-FC series

External setting

※ This option is not available to FCS-100, 200 series.

When adding this option, it will be possible to set the SV by analog signal from a remote position. The input signal type is to be designated when ordering.

※ The PV input sampling period will be 500ms in case this option is added.
 ※ In case the control output type is ON/OFF servo, the input sampling period becomes 250ms.

[Specifications]

Setting parameter SV
 Input signal type To be designated when ordering from the followings
 • 0-20mA_{dc}
 • 4-20mA_{dc}
 • 0-1V_{dc}
 • 1-5V_{dc}
 Input impedance approx. 50Ω (When applied mA input)
 approx. 100kΩ (When applied V input)

Serial communication

※ This option is not available to FCS-100 series.

When adding this option, it will be possible to do data-setting of FC series and monitoring the process with a host computer. The communicating interface type should be designated when ordering.

※ When requiring the RS-485 interface type if the host computer is not applicable to RS-485, our communication converter (sold separately) will be useful.

[Specifications]

Communication interface To be designated when ordering from the followings
 • Based on EIA RS-232C
 • Based on EIA RS-485
 Communicating contents
 Each setting and operation of FC series
 Host computer
 The computer which has the RS-232C interface
 (Communication converter is used when connecting RS-485)
 Using character code
 ASCII character code
 Number of FC series connectable RS-232C...1
 RS-485...maximum 31
 Data transfer rate 2400, 4800, 9600 or 19200bps (selectable by key operation)
 Communication method Half-duplex communication start-stop synchronous
 Communicating error detection Dual-detection of parity check and check-sum check

Insulated power output

※ This option is not applicable when the control output type is ON/OFF servo, and is not available to FCS-200 series, too.

※ This option is not applicable with a combination of Alarm 2, Heating/Cooling control or Loop break alarm.

This option is utilized for small capacity power source of each sensor or converter.

[Specifications]

Output 24±3V_{dc} Maximum 30mA
 Ripple voltage: Within 200mV

Others

● Color black

The standard color is light gray. If this option is designated, the color will be black (Additional price is not needed).

● Screw type mounting bracket

The mounting bracket for FCR-100 and FCS-100 series is one-touch type, but when adding this option, screw type mounting bracket will be the accessory (Additional price is not needed).

● Terminal cover

When adding this option, the terminal cover will be added to the accessories. If there is a possibility that someone touches the back side of the FC series during running, be sure to designate this option and keep mounting the terminal cover.

● Dust-proof-Drip-proof

When adding this option, the Dust-proof-Drip-proof specification on the front panel will be raised to IEC IP54 (The standard is IP50).

Names and functions of each part



FCD-100 series



FCR-100 series



FCS-100, 200 series

FCD-100, FCR-100 series

1 PV display

Displays the PV. During setting operation, displays the setting items by the characters.

2 SV/MV/TIME display

Displays either SV, MV or TIME (Step rest time). — Refer to the page 11 for how-to-change the displays. Time can be displayed for programming control. During setting operation, displays the registered functions and values.

3 MEMO display

Displays the calling setting value memory number.

4 SV indicator

Lights when the SM/MV/TIME displays the SV.

5 MV indicator

Lights when the SM/MV/TIME displays the MV.

6 TIME indicator

Lights when the SV/MV/TIME displays the step rest TIME.

7 A1 indicator

Lights when the Alarm 1 is ON.

8 A2 indicator

Lights when the Alarm 2 (option) is ON.

9 A3 indicator

Lights when the Alarm 3 (option) is ON.

10 A4 indicator

Lights when the Alarm 4 (option) is ON.

11 HB indicator

Lights when the Heater burnout alarm (option) is ON.

12 OUT1 indicator

Lights when the Control output 1 is ON.

13 OUT2 indicator

Lights when the Control output 2 (option) is ON.

14 Manual indicator

Lights when the manual control is performed.

15 TX/RX indicator

During serial communication (option), lights when it responds to the command from the host computer.

16 REMOTE indicator

Lights when the External setting (option) keeps effective.

17 AT indicator

Blinks when performing the PID auto-tuning.

18 SB indicator

Lights when the sensor is broken (excepting when applied 0-20mA input).

19 LA indicator

Lights when the Loop break alarm (option) is ON.

1 Increase key

2 Decrease key

3 Fast key

4 Mode key

5 Control output OUT/OFF key

6 Automatic/Manual key



Refer to Operation example (page 11) for usage.

FCS-100, 200 series

1 PV display

Displays the PV. During setting operation, displays the setting items by the characters.

2 SV display

Displays either SV or MV. — Refer to the page 11 for how-to-change the displays. During setting operation, displays the registered functions and values.

3 OUT indicator

Lights when the Control output is ON.

4 A1 indicator

Lights when the Alarm 1 is ON.

5 A2 indicator

Lights when the sensor is broken. Moreover, lights when the Alarm 2 (option) and/or the Heater burnout alarm (option) are ON.

6 AT indicator

Blinks when performing the PID auto-tuning.

1 Increase key

2 Decrease key

3 Mode key

4 Control output OUT/OFF key



Refer to Operation example (page 11) for usage.

Operation examples

This page gives the examples of the operations. To operate the FC series actually, confirm beforehand the notices and so on written in the instruction manual.

SV setting

1. Pressing the MODE key brings the displays to the SV setting which displays " 4 " on the PV and the registered value on the SV.

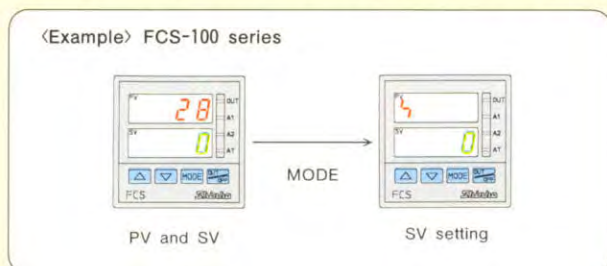

2. In the SV setting display, SV can be changed as follows.
 - Press the ▲ → SV increases (Changes faster when held)
 - Press the ▼ → SV decreases (Changes faster when held)
- ※ As for the FCD-100 and FCR-100 series, press the FAST key together to change the SV quickly.
3. After pressed the mode key once again, the display returns to the PV and SV.

Display change

1. Pressing MODE key for three seconds brings the lower display to the MV display (Displays SV until MV appears).

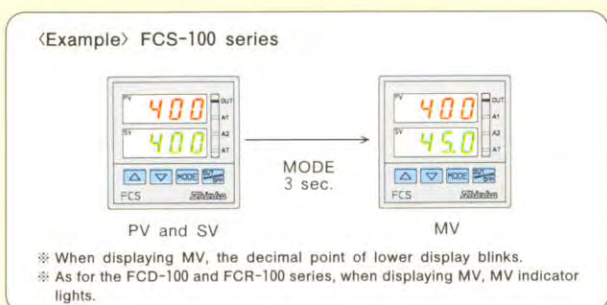

The FCD-100 and FCR-100 series can display the step rest TIME during the simplified program controlling.

2. After pressed the mode key once again, the display returns to the PV and SV.

Setting value memory number selection

※ This function is not available to FCS-100 series.

1. Pressing the MODE key while the INCREASE key is being pressed brings the displays to the setting value memory number selection which displays " 000 " on the PV and the using memory number on the SV/MV/TIME.

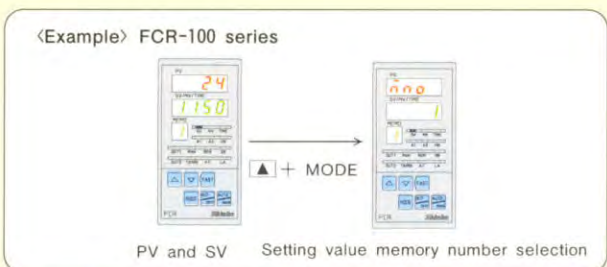

2. Pressing the INCREASE key or DECREASE key changes the using memory file number.
3. Pressing the MODE key for three seconds brings the displays to the PV and SV via AT performing display.

AT performance

※ AT: PID auto-tuning

1. AT performing display can be called as follows.
 - As to the FCS-100 series, press the MODE key while the INCREASE key is being pressed.
 - As to the FCD-100, FCR-100 and FCS-200 series, press the MODE key while the INCREASE key is being pressed, then press the MODE key once.
- In the AT performing display, the characters " RΓ " and " - - - - " are displayed.

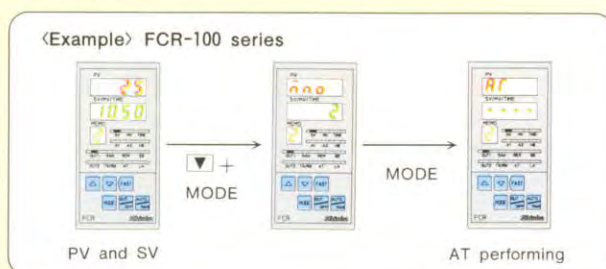

2. Pressing the INCREASE key changes the display from " - - - - " to " RΓ ". AT starts when the MODE key is pressed, and the display returns to PV and SV.
 - ※ To cancel the AT during the process, call the AT performing display, and press the DECREASE key to change the display from " RΓ " to " - - - - ", and then return the display to PV and SV by using the MODE key.

Control output OFF

When the OUT/OFF key is pressed for approx. 1 second, character " F F " is indicated on the PV display, and the status turns to Control output OFF. When controlling again, press the OUT/OFF key for approx. 1 second.

※ With the Simplified program control, this key is used to change the status RUN/STANDBY.

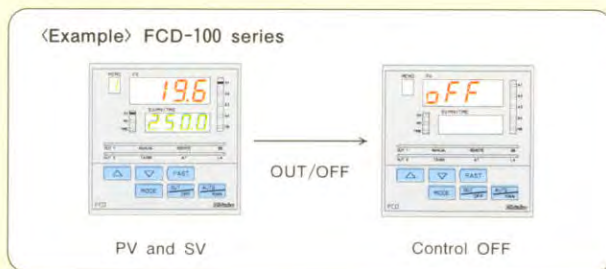

AUTO/MAN changing

※ This function is not available to the FCS-100, 200 series.

Pressing the AUTO/MAN key changes the control mode from automatic to manual and the manipulating value (MV) is displayed on the SV/MV/TIME. The MV can be changed by the INCREASE, DECREASE and FAST keys operation. The control mode will return to the automatic by pressing the AUTO/MAN key once again.

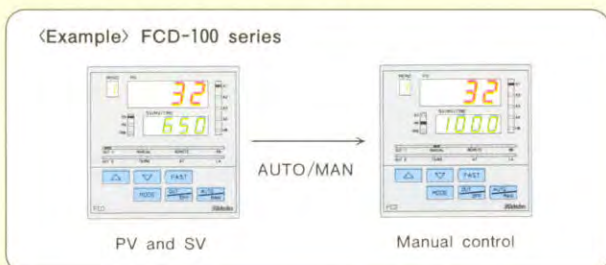

Mounting and wiring

Terminal arrangement

FCD-100 series

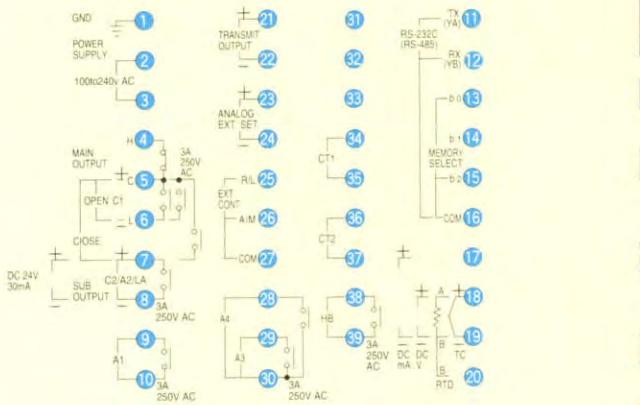

※ Terminal screw size is M3.

FCR-100 series

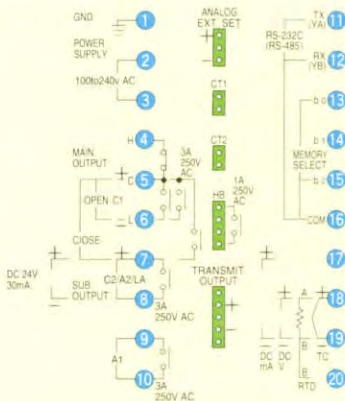

※ Terminal screw size is M3.

※ Green-colored terminals: receptacle (accessory)

FCS-100, 200 series

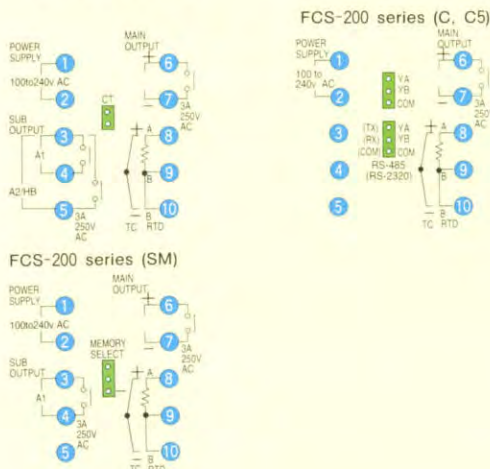

※ Terminal screw size is M3.

※ Green-colored terminals: receptacle (accessory)

Notice

When mounting or wiring, the operation must be performed following the descriptions and notices of the instruction manual to avoid the accident such as electric shock.

GND Ground terminal

FCS-100 series does not have ground terminal.

POWER SUPPLY Power supply terminals

The voltage printed on the left label shows the allowable voltage fluctuation.

MAIN OUTPUT Control output 1 output terminals

When applied the ON/OFF servo type, OPEN output : ⑤ and ⑥
CLOSED output: ⑤ and ⑦.

TC Thermocouple input terminals

PV input terminals when thermocouple input is applied.

RTD RTD input terminals

PV input terminals when RTD input is applied.

DCV 0-1V input terminals

PV input terminals when 0-1V input is applied.

DCmA 4-20mA and 0-20mA input terminals

PV input terminals when 4-20mA or 0-20mA input is applied.

A1 Alarm 1 output terminals

A2/HB Alarm 2 and Heater burnout alarm output terminals

※ FCS-100 series, when applied Alarm2 and/or Heater burnout alarm

When applied the both options, they will be common output terminals

CT CT input terminals

※ FCS-100 series, when applied Heater burnout alarm

C2/A2/LA Control output2, Alarm 2 and Loop break alarm output terminals

※ FCD-100 and FCR-100 series, when applied either Control output 2, Alarm 2 or Loop break alarm

When applied Alarm 2 and Loop break alarm together, they will be common output terminals

TRANSMIT OUTPUT Transmission output terminals

※ FCD-100 and FCR-100 series, when applied Transmission output

ANALOG EXT. SET External setting input terminals

※ FCD-100 and FCR-100 series, when applied External setting

EXT CONT External operation input terminals

※ FCD-100 series, when applied External setting

A3 A4 Alarm 3 and Alarm 4 output terminals

※ FCD-100 series, when applied Alarm 3, 4

CT1 CT2 CT input terminals

※ FCD-100 and FCR-100 series, when applied Heater burnout alarm

When applied the function for single phase, connect the wire to CT1 terminals; when applied for 3-phase, to CT1 and CT2.

HB Heater burnout alarm output terminals

※ FCD-100 and FCR-100 series, when applied Heater burnout alarm

RS-232C(RS-485) Serial communication terminals

※ FCD-100, FCR-100 and FCS-200 series, when applied Serial communication

MEMORY SELECT Setting value memory number external change terminals

※ FCD-100 and FCR-100 series, when applied Setting value memory number external change

DC24V Insulated power output terminal

※ FCD-100 and FCR-100 series, when applied Insulated power output.

※ Not available to ON/OFF servo output type.

※ Not applicable with a combination of Alarm 2, Heating/Cooling Control output and Loop break alarm.

Mounting and wiring

External dimension

※ Mounting panel thickness is 1 to 15mm (when using screw type mounting bracket) or 1 to 3mm (when using one-touch mounting bracket).

● FCD-100 series

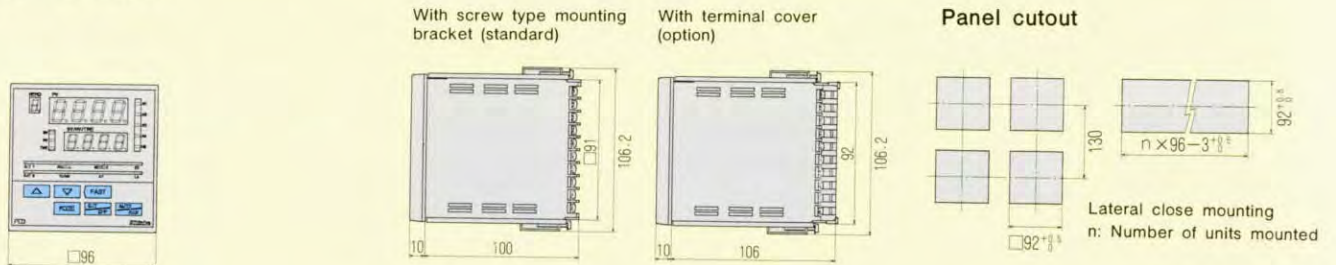

● FCR-100 series

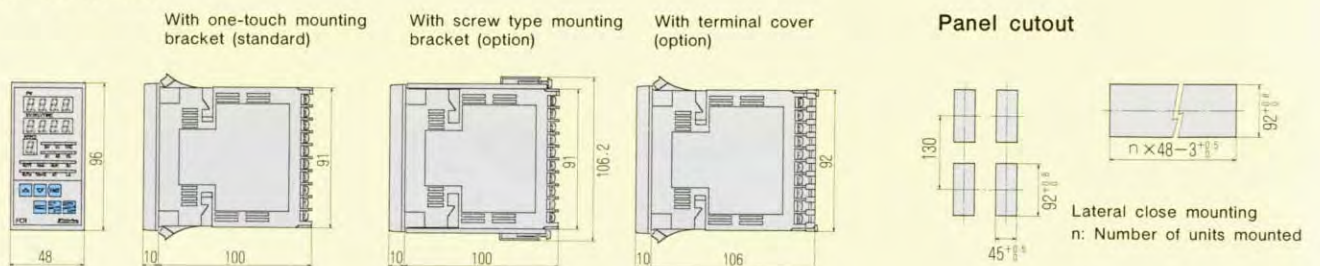

● FCS-100, 200 series

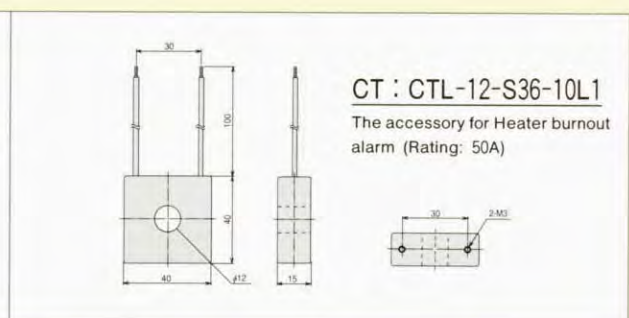
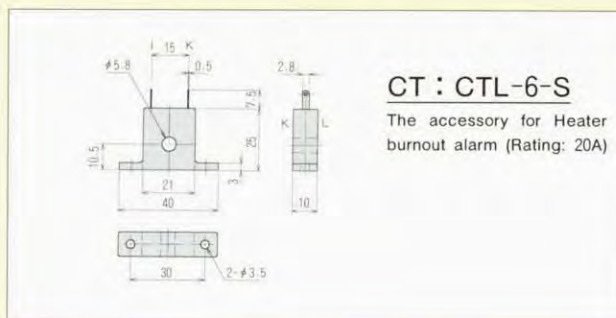
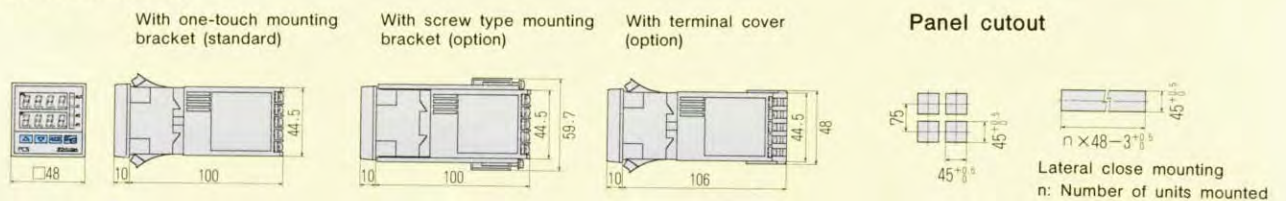

Wiring connection examples

FCS-100 series Relay contact output type

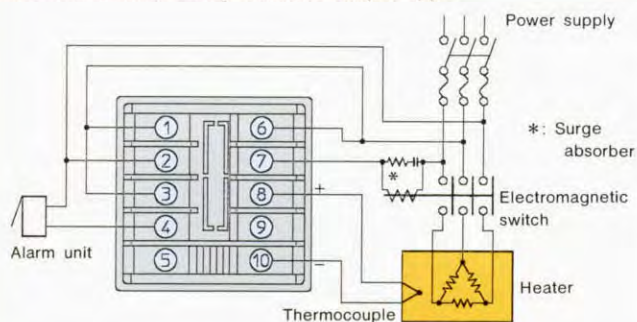

※ Influence of external noise can be reduced providing the Surge absorber between the coils of the external electromagnetic switch

FCR-100 series Current output type

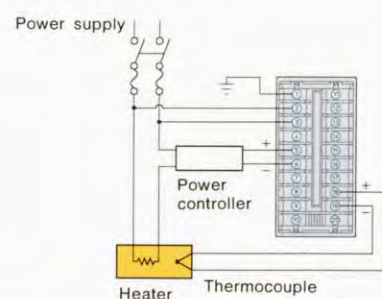

※ Power controller: Our supply goods, PA-200 series

FCD-100 series

96×96×100mm (W×H×D)

Model name

FCD-1 <input type="checkbox"/> A- <input type="checkbox"/> /M, <input type="checkbox"/>		FCD-100 series (96×96mm Digital indicating controller)		
Control action	3 5	PID (Selectable with FUNCTION DIP switch)		
Alarm 1 output action	A	* 1	ON/OFF servo output PID (Selectable with FUNCTION DIP switch)	
Control output	R	Relay contact		
	S	Non-contact voltage (for SSR drive)		
	A	Current (4-20mA)		
PV input	M	Multi-range system (See below "Input rating" for the types)		
Option (Refer to the pages 8 to 9)	A2	* 2	Alarm 2 (Selectable with A2 Rotary switch)	
	BK		Color black	
	C		Serial communication	
	C5		RS-232C RS-485	
	DR		Relay contact output	
	DS	* 3	Heating and Cooling control (Control output 2)	
	DA		Non-contact voltage output (for SSR drive) Current output (4-20mA)	
	EA (0-20)		External setting	
	EA (4-20)		0-20mA input	
	EV (0-1)		4-20mA input	
	EV (1-5)		0-1V input 1-5V input	
	IP		Dust-proof-Drip-proof (IP54)	
	LA	* 4	Loop break alarm	
	SA		Alarm 3, 4	
	SM		Setting value memory number external change	
	TA		Transmission output	
	TV		4-20mA output 0-1V output	
	TC		Terminal cover	
	W (20A)	* 5	Heater burnout alarm	For single phase
	W (50A)			20A 50A
W3 (20A)	For 3-phase			
W3 (50A)	20A 50A			
P24	* 6	Insulated power output	24±3Vdc Maximum 30mA	

※ When selecting (*1), designate the Relay contact type as the Control output (the others are not applicable).

※ When selecting (*1), the options (*2), (*3), (*4) and (*5) cannot be added.

※ (*3) is not available with a combination of (*2) or (*4). When added (*2) and (*4) together, the output of them is common.

※ (*6) is not available with a combination of (*2), (*3) and (*4).

※ When selecting Current type (FCD-13A-A/M) as the control output, the (*5) cannot be added.

NOTES WHEN ORDERING

- When ordering, designate the model name, the supply voltage (either 100-240Vac or 24Vac/dc) and the quantity.
- When adding the plural options, mark off their option codes by commas.

Input rating (Shipped as thermocouple K)

PV input type		Scale		Indicating resolution	Burnout display
Thermocouple	K	-200 to 1370 °C	-320 to 2500 °F	1 °C (°F)	Upscale
	J	-200 to 1000 °C	-320 to 1800 °F	1 °C (°F)	
	R	0 to 1760 °C	0 to 3200 °F	1 °C (°F)	
	S	0 to 1760 °C	0 to 3200 °F	1 °C (°F)	
	B	0 to 1820 °C	0 to 3300 °F	1 °C (°F)	
	E	0 to 1000 °C	0 to 1800 °F	1 °C (°F)	
	T	-199.9 to 400.0°C	-199.9 to 750.0°F	0.1 °C (°F)	
	C (W/Re5-26)	0 to 2315 °C	0 to 4200 °F	1 °C (°F)	
	N	0 to 1300 °C	0 to 2300 °F	1 °C (°F)	
PL-II	0 to 1390 °C	0 to 2500 °F	1 °C (°F)		
RTD	Pt100	-200 to 850 °C	-320 to 1560 °F	1 °C (°F)	Upscale
	Pt100	-199.9 to 850.0°C	-199.9 to 999.9°F	0.1 °C (°F)	
	JPt100	-199.9 to 500.0°C	-199.9 to 900.0°F	0.1 °C (°F)	
DC	4 to 20mA	-1999 to 9999, -199.9 to 999.9, -19.99 to 99.99 or -1.999 to 9.999	1, 0.1, 0.01 or 0.001	Downscale	
	0 to 20mA			The same as 0mA input	
	0 to 1V			Upscale	

※ The PV input type is changeable by multi-range function.

※ When selected thermocouple or RTD input, the SV settable range and the temperature unit (C/F) are changeable.

※ When selected DC input, the scale range and the decimal point place are changeable.



Standard specifications

Displays	<p>PV 7-segment Red LED, 4-digit Size 14.3×8mm (H×W)</p> <p>SV/MV/TIME 7-segment Green LED, 4-digit Size 10×5.5mm (H×W)</p> <p>MEMO 7-segment Yellow LED, 1-digit Size 8×4mm (H×W)</p> <p>Others Refer to the "Names and functions of each part (page 10)".</p>
PV input	<p>External resistance, Allowable input lead wire resistance and Input impedance</p> <ul style="list-style-type: none"> Thermocouple External resistance, 100Ω or less RTD Allowable input lead wire resistance, 10Ω or less per wire 4-20, 0-20mA Input impedance, 50Ω Allowable input current, 100mA or less 0-1V Input impedance, 1MΩ or greater Allowable signal source resistance, 2kΩ or less Allowable input voltage, 5V or less <p>* Refer to the "Input rating (previous page)" as for the types, scales, indicating resolutions and burnout displays.</p>
Accuracy (Setting and Indication)	<p>Within ±0.2% of full scale ±1 digit, however,</p> <p>In case of thermocouple input</p> <ul style="list-style-type: none"> ±1°C (2°F) of Cold junction compensating error should be added. For K, J, T type, and less than 0°C (32°F), within ±0.4% of full scale ±1 digit For R or S type, on the range 0 to 200°C (400°F), within ±4°C (8°F) For B type, on the range 0 to 300°C (600°F), without the range of accuracy guarantee
Input sampling period	125ms (however, 500ms when option Heater burnout alarm or External setting is applied, and 250ms when option External setting is applied to the type ON/OFF servo output type is applied.)
Control action	<p>Selectable by FUNCTION DIP switch from the followings</p> <ul style="list-style-type: none"> Fuzzy self tuning PID (with auto-tuning function) <ul style="list-style-type: none"> Proportional cycle 1 to 120s (not available when control output type is current) Others P,I,D values are automatically set PID (with auto-tuning function) <ul style="list-style-type: none"> Proportional band (P) 0.1 to 999.9% of full scale Integral time (I) 0 to 3600s (no function when set to 0) Derivative time (D) 0 to 3600s (no function when set to 0) Proportional cycle 1 to 120s (not available when control output type is current) PD <ul style="list-style-type: none"> Proportional band (P) 0.1 to 999.9% of full scale Derivative time (D) 0 to 3600s (no function when set to 0) Manual reset value ± Proportional band span Proportional cycle 1 to 120s (not available when control output type is current) ON/OFF <ul style="list-style-type: none"> Hysteresis When applying thermocouple or RTD input: 0.1 to 100.0°C (°F) When applying DC input : 1 to 1000 (Decimal point place follows the setting)
Control output	<p>To be designated when ordering from the followings</p> <ul style="list-style-type: none"> Relay contact 1a1b Resistive load: 3A (250Vac), Inductive load: 1A (250Vac, cos φ=0.4) Non-contact voltage For SSR drive 12^{+2}_0 Vdc (40mA max.) Current 4-20mA_{dc} (Isolated type) Load resistance: 550Ω max. ON/OFF servo Relay contact, 1a×2 (with valve opening rate auto-arithmetic function) Resistive load: 3A (250Vac), Inductive load: 1A (250Vac, cos φ=0.4)
Alarm 1	<p>Output action Select the action by A1 rotary switch Standby function and Alarm action delayed timer can be designated.</p> <ul style="list-style-type: none"> No function High limit action (Deviation setting) Setting range: ±Input range span (OFF when set to 0) Low limit action (Deviation setting) Setting range: ±Input range span (OFF when set to 0) Non/Low limits action (Deviation setting) Setting range: 0 to ±Input range span (OFF when set to 0) High/Low limit range action (Deviation setting) Setting range: 0 to ±Input range span (OFF when set to 0) Process value high limit action Setting range: ±Input range minimum to maximum value Process value low limit action Setting range: ±Input range minimum to maximum value <p>* The values not displayed (values below -1999) cannot be set.</p> <p>Setting accuracy The same as the accuracy of PV input indication</p> <p>Control action ON/OFF action</p> <p>Hysteresis Thermocouple or RTD input type: 0.1 to 100.0°C (°F)</p> <p>DC input type : 1 to 1000 (Decimal point place follows the setting)</p> <p>Control output Relay contact 1a Resistive load: 3A (250Vac), Inductive load: 1A (250Vac, cos φ=0.4)</p>
Supply voltage	<p>To be designated when ordering from the followings</p> <ul style="list-style-type: none"> 100 to 240Vac 50/60Hz Allowable voltage fluctuation: 85 to 264Vac 24Vac/dc (Duplex use) Allowable voltage fluctuation: 20 to 28Vac/dc
Power consumption	Approx. 15VA (maximum)
Instantaneous power failure	Within 30ms Data keeping: Non-volatile memory
Insulation, Dielectric strength	<p>Insulation resistance 10MΩ or greater when applying 500Vdc to the terminals (except between non-insulated terminals)</p> <p>Dielectric strength Between Input terminal and Ground terminal/Power terminal, 1.5kVac for 1 min</p> <p>Between Power terminal and Ground terminal, 1.5kVac for 1 min</p> <p>Between Output terminal and Ground terminal/Power terminal, 1.5kVac for 1 min</p>
Environment	Ambient temperature: 0 to 50°C, Ambient humidity: 35 to 85%RH (non-condensing)
Size · Weight	Size: Refer to "External dimension (page 13)", Weight: approx. 550 g
Material · Color	Material: Flame resistance resin Color: Light gray or Black (black: option)
Mounting method	Flush To be fixed with screw type mounting bracket
Setting system	Key-input system (Another system is available by adding the option)
Attached function	Refer to the pages 6 to 7.
Accessories	1 set of mounting bracket, 1 copy of instruction manual, 1 sheet of unit nameplate

FCR-100 series

48×96×100mm (W×H×D)

Model name

FCR-1 <input type="checkbox"/> A- <input type="checkbox"/> /M, <input type="checkbox"/>		FCR-100 series (48×96mm Digital indicating controller)		
Control action	3		PID (Selectable with FUNCTION DIP switch)	
	5		* 1 ON/OFF servo output PID (Selectable with FUNCTION DIP switch)	
Alarm 1 output action	A		Multi-action system (Selectable with A1 Rotary switch)	
Control output	R		Relay contact	
	S		Non-contact voltage (for SSR drive)	
	A		Current (4-20mA _{dc})	
PV input	M		Multi-range system (See below "Input rating" for the types)	
Option (Refer to the pages 8 to 9)	A2	* 2	Alarm 2 (Selectable with A2 Rotary switch)	
	BK		Color black	
	BL		Screw type mounting bracket	
	C		Serial communication	
	C5			RS-232C
	DR		Heating and Cooling control (Control output 2)	
	DS	* 3		Relay contact output
	DA			Non-contact voltage output (for SSR drive)
	EA (0-20)		External setting	
	EA (4-20)			Current output (4-20mA _{dc})
	EV (0-1)			0-20mA input
	EV (1-5)			4-20mA input
	IP			0-1V input
	LA	* 4		1-5V input
	SM			Dust-proof-Drip-proof (IP54)
	TA			Loop break alarm
	TV			Setting value memory number external change
	TC			Transmission output
	W (20A)			4-20mA output
	W (50A)			0-1V output
W3 (20A)			Terminal cover	
W3 (50A)				
P24	* 6		Heater burnout alarm	
				For single phase
			20A	
			50A	
			For 3-phase	
			20A	
			50A	
			Insulated power output	
			24±3Vdc Maximum 30mA	

- ※ When selecting (*1), designate the Relay contact type as the Control output (the others are not applicable).
- ※ When selecting (*1), the options (*2), (*3), (*4) and (*5) cannot be added.
- ※ (*3) is not available with a combination of (*2) or (*4). When added (*2) and (*4) together, the output of them is common.
- ※ (*6) is not available with a combination of (*2), (*3) and (*4).
- ※ When selecting Current type (code: A) as the control output, the (*5) cannot be added.

NOTES WHEN ORDERING

- When ordering, designate the model name, the supply voltage (either 100-240Vac or 24Vac/dc) and the quantity.
- When adding the plural options, mark off their option codes by commas.

Input rating (Shipped as thermocouple K)

PV input type		Scale		Indicating resolution	Burnout display
Thermocouple	K	-200 to 1370 °C	-320 to 2500 °F	1 °C (°F)	Upscale
	J	-200 to 1000 °C	-320 to 1800 °F	1 °C (°F)	
	R	0 to 1760 °C	0 to 3200 °F	1 °C (°F)	
	S	0 to 1760 °C	0 to 3200 °F	1 °C (°F)	
	B	0 to 1820 °C	0 to 3300 °F	1 °C (°F)	
	E	0 to 1000 °C	0 to 1800 °F	1 °C (°F)	
	T	-199.9 to 400.0°C	-199.9 to 750.0°F	0.1 °C (°F)	
	C (W/Re5-26)	0 to 2315 °C	0 to 4200 °F	1 °C (°F)	
	N	0 to 1300 °C	0 to 2300 °F	1 °C (°F)	
	PL-II	0 to 1390 °C	0 to 2500 °F	1 °C (°F)	
RTD	Pt100	-200 to 850 °C	-320 to 1560 °F	1 °C (°F)	Upscale
	Pt100	-199.9 to 850.0°C	-199.9 to 999.9°F	0.1 °C (°F)	
	JPt100	-199.9 to 500.0°C	-199.9 to 900.0°F	0.1 °C (°F)	
DC	4 to 20mA	-1999 to 9999, -199.9 to 999.9, -19.99 to 99.99 or -1.999 to 9.999		1, 0.1, 0.01 or 0.001	Downscale
	0 to 20mA				The same as 0mA input
	0 to 1V				Upscale

- ※ The PV input type is changeable by multi-range function.
- ※ When selected thermocouple or RTD input, the SV settable range and the temperature unit (°C/°F) are changeable.
- ※ When selected DC input, the scale range and the decimal point place are changeable.



Standard specifications

Displays	<p>PV 7-segment Red LED, 4-digit Size 8×4mm (H×W)</p> <p>SV/MV/TIME 7-segment Green LED, 4-digit Size 8×4mm (H×W)</p> <p>MEMO 7-segment Yellow LED, 1-digit Size 8×4mm (H×W)</p> <p>Others Refer to the "Names and functions of each part (page 10)".</p>
PV input	<p>External resistance, Allowable input lead wire resistance and Input impedance</p> <ul style="list-style-type: none"> • Thermocouple External resistance, 100 Ω or less • RTD Allowable input lead wire resistance, 10 Ω or less per wire • 4-20, 0-20mA Input impedance, 50 Ω Allowable input current, 100mA or less • 0-1V Input impedance, 1M Ω or greater Allowable signal source resistance, 2k Ω or less Allowable input voltage, 5V or less <p>* Refer to the "Input rating (previous page)" as for the types, scales, indicating resolutions and burnout displays.</p>
Accuracy (Setting and Indication)	<p>Within ±0.2% of full scale ±1 digit, however,</p> <p>In case of thermocouple input</p> <ul style="list-style-type: none"> • ±1°C (2°F) of Cold junction compensating error should be added. • For K, J, T type, and less than 0°C (32°F), within ±0.4% of full scale ±1 digit • For R or S type, on the range 0 to 200°C (400°F), within ±4°C (8°F) • For B type, on the range 0 to 300°C (600°F), without the range of accuracy guarantee
Input sampling period	125ms (however, 500ms when option Heater burnout alarm or External setting is applied, and 250ms when option External setting is applied to the type ON/OFF servo output type is applied.)
Control action	<p>Selectable by FUNCTION DIP switch from the followings</p> <ul style="list-style-type: none"> • Fuzzy self tuning PID (with auto-tuning function) <ul style="list-style-type: none"> Proportional cycle 1 to 120s (not available when control output type is current) Others P,I,D values are automatically set • PID (with auto-tuning function) <ul style="list-style-type: none"> Proportional band (P) 0.1 to 999.9% of full scale Integral time (I) 0 to 3600s (no function when set to 0) Derivative time (D) 0 to 3600s (no function when set to 0) Proportional cycle 1 to 120s (not available when control output type is current) • PD <ul style="list-style-type: none"> Proportional band (P) 0.1 to 999.9% of full scale Derivative time (D) 0 to 3600s (no function when set to 0) Manual reset value ± Proportional band span Proportional cycle 1 to 120s (not available when control output type is current) • ON/OFF <ul style="list-style-type: none"> Hysteresis When applying thermocouple or RTD input: 0.1 to 100.0°C (°F) When applying DC input : 1 to 1000 (Decimal point place follows the setting)
Control output	<p>To be designated when ordering from the followings</p> <ul style="list-style-type: none"> • Relay contact 1a1b Resistive load: 3A (250Vac), Inductive load: 1A (250Vac, cos φ=0.4) • Non-contact voltage For SSR drive $12 \pm \frac{2}{0}$ Vdc (40mA max.) • Current 4-20mAdc (Isolated type) Load resistance: 550 Ω max. • ON/OFF servo Relay contact, 1a×2 (with valve opening rate auto-arithmetic function) Resistive load: 3A (250Vac), Inductive load: 1A (250Vac, cos φ=0.4)
Alarm 1	<p>Output action Select the action by A1 rotary switch Standby function and Alarm action delayed timer can be designated.</p> <ul style="list-style-type: none"> • No function • High limit action (Deviation setting) Setting range: ±Input range span (OFF when set to 0) • Low limit action (Deviation setting) Setting range: ±Input range span (OFF when set to 0) • High/Low limits action (Deviation setting) Setting range: 0 to ±Input range span (OFF when set to 0) • High/Low limit range action (Deviation setting) Setting range: 0 to ±Input range span (OFF when set to 0) • Process value high limit action Setting range: ±Input range minimum to maximum value • Process value low limit action Setting range: ±Input range minimum to maximum value <p>* The values not displayed (values below -1999) cannot be set.</p> <p>Setting accuracy The same as the accuracy of PV input indication</p> <p>Control action ON/OFF action</p> <p>Hysteresis Thermocouple or RTD input type: 0.1 to 100.0°C (°F)</p> <p>DC input type : 1 to 1000 (Decimal point place follows the setting)</p> <p>Control output Relay contact 1a Resistive load: 3A (250Vac), Inductive load: 1A (250Vac, cos φ=0.4)</p>
Supply voltage	<p>To be designated when ordering from the followings</p> <ul style="list-style-type: none"> • 100 to 240Vac 50/60Hz Allowable voltage fluctuation: 85 to 264Vac • 24Vac/dc (Duplex use) Allowable voltage fluctuation: 20 to 28Vac/dc
Power consumption	Approx. 15VA (maximum)
Instantaneous power failure	Within 30ms Data keeping: Non-volatile memory
Insulation, Dielectric strength	<p>Insulation resistance 10M Ω or greater when applying 500Vdc to the terminals (except between non-insulated terminals)</p> <p>Dielectric strength Between Input terminal and Ground terminal/Power terminal, 1.5kVac for 1 min</p> <p>Between Power terminal and Ground terminal, 1.5kVac for 1 min</p> <p>Between Output terminal and Ground terminal/Power terminal, 1.5kVac for 1 min</p>
Environment	Ambient temperature: 0 to 50°C, Ambient humidity: 35 to 85%RH (non-condensing)
Size · Weight	Size: Refer to "External dimension (page 13)", Weight: approx. 320 g
Material · Color	Material: Flame resistance resin Color: Light gray or Black (black: option)
Mounting method	Flush To be fixed with one-touch mounting bracket, or screw type mounting bracket (option)
Setting system	Key-input system (Another system is available by adding the option)
Attached function	Refer to the pages 6 to 7.
Accessories	1 set of mounting bracket, 1 copy of instruction manual, 1 sheet of unit nameplate

FCS-100, 200 series

48×48×100mm (W×H×D)

Model name

FCS-□ 3 A -□/M, □		FCS-100, 200 series (48×48mm Digital indicating controller)		
Series name	1	FCS-100 series		
	2	FCS-200 series		
Control action	3	PID (Action is selectable by DIP switch)		
Alarm 1 output action	A	Multi-action system (Action is selectable)		
Control output	R	Relay contact		
	S	Non-contact voltage (for SSR drive)		
	A	Current (4-20mA)		
PV input	M	Multi-range system (See Input rating item)		
Option (Refer to the page 8 to 9)	A2	* 1	Alarm 2 (Selectable by A2 rotary switch)	
	BK		Color black	
	BL		Screw type mounting bracket	
	C	* 2	Serial communication	
	C5			RS-232C
	IP		Dust proof, Drip proof (IP54)	
	LA	* 3	Loop break alarm	
	SM	* 4	Setting value memory number external change	
	TC		Terminal cover	
	W (20A)	* 5	Heater burnout alarm (for Single phase)	20A
	W (50A)			50A

- When (*1) and (*3), or (*1) and (*5) are used together, the output becomes common.
- (*2), (*3) or (*4) is not applicable to the FCS-100 type.
- (*5) is not applicable to the FCS-200 type.
- (*2) is not applicable with a combination of (*1), (*3) and (*4).
- (*4) is not applicable with a combination of (*1), (*2) and (*3).
- In case the control output type is designated to Current type (FCS-13A-A/M), option (*4) cannot be applied.

NOTES WHEN ORDERING

1. When ordering, designate the model name, the supply voltage (either 100-240Vac or 24Vac/dc) and the quantity.
2. When adding the plural options, mark off their option codes by commas.

[Ordering example]

1. FCS-13A-R/M 100-240V
 - Control output: Relay contact type
 - Options: No option will be applied
 - Supply voltage: 100 to 240Vac
2. FCS-13A-S/M, BK, W (20A) 100-240V
 - Control output: Non-contact voltage type
 - Options: Color black and Heater burnout alarm (20A) will be applied
 - Supply voltage: 100 to 240Vac
3. FCS-13A-A/M, IP, TC 24V
 - Control output: Current type
 - Options: Dust-proof-Drip-proof and Terminal cover will be applied
 - Supply voltage: 24Vac/dc

Input rating (Shipped as thermocouple K)

PV input type		Scale		Indicating resolution	Burnout display
Thermocouple	K	-200 to 1370 °C	-320 to 2500 °F	1 °C (°F)	Upscale
	J	-200 to 1000 °C	-320 to 1800 °F	1 °C (°F)	
	R	0 to 1760 °C	0 to 3200 °F	1 °C (°F)	
	S	0 to 1760 °C	0 to 3200 °F	1 °C (°F)	
	B	0 to 1820 °C	0 to 3300 °F	1 °C (°F)	
	E	0 to 1000 °C	0 to 1800 °F	1 °C (°F)	
	T	-199.9 to 400.0°C	-199.9 to 750.0°F	0.1 °C (°F)	
	C (W/Re5-26)	0 to 2315 °C	0 to 4200 °F	1 °C (°F)	
	N	0 to 1300 °C	0 to 2300 °F	1 °C (°F)	
	PL-II	0 to 1390 °C	0 to 2500 °F	1 °C (°F)	
RTD	Pt100	-200 to 850 °C	-320 to 1560 °F	1 °C (°F)	Upscale
	Pt100	-199.9 to 850.0°C	-199.9 to 999.9°F	0.1 °C (°F)	
	JPt100	-199.9 to 500.0°C	-199.9 to 900.0°F	0.1 °C (°F)	

- The PV input type is selectable by multi-range system.
- In case of FCS-100 type, selectable only K, J, R, B, PL-II, N, Pt100 (w/decimal point) and JPt100 (w/decimal point) types.
- The settable range and the temperature unit (°C or °F) are selectable.



Standard specifications

Displays	PV 7-segment Red LED, 4-digit Size 8×4mm (H×W) SV/MV/TIME 7-segment Green LED, 4-digit Size 8×4mm (H×W) Others Refer to the "Names and functions of each part (page 10)".
PV input	External resistance and Allowable input lead wire resistance <ul style="list-style-type: none"> Thermocouple External resistance, 100Ω or less RTD Allowable input lead wire resistance: 10Ω or less per wire * Refer to the "Input rating (previous page)" as for the types, scales, indicating resolutions and burnout displays.
Accuracy (Setting and Indication)	Within ±0.3% of full scale ±1 digit, however, In case of thermocouple input <ul style="list-style-type: none"> ±1.5°C (3°F) of Cold junction compensating error should be added. For K, J, T type, and less than 0°C (32°F), within ±0.5% of full scale ±1 digit For R type, on the range 0 to 200°C (400°F), within ±6°C (±12°F) For B type, on the range 0 to 300°C (600°F), without the range of accuracy guarantee
Input sampling period	125ms (however, 250ms when option Heater burnout alarm is applied.)
Control action	Selectable by FUNCTION DIP switch from the followings <ul style="list-style-type: none"> Fuzzy self tuning PID (with auto-tuning function) Proportional cycle 1 to 120s (not available when control output type is current) Others P,I,D values are automatically set PID (with auto-tuning function) Proportional band (P) 0.1 to 100.0% of full scale Integral time (I) 0 to 3600s (no function when set to 0) Derivative time (D) 0 to 3600s (no function when set to 0) Proportional cycle 1 to 120s (not available when control output type is current) PD Proportional band (P) 0.1 to 100.0% of full scale Derivative time (D) 0 to 3600s (no function when set to 0) Manual reset value ± Proportional band span Proportional cycle 1 to 120s (not available when control output type is current) ON/OFF Hysteresis 0.1 to 100.0°C (°F)
Control output	To be designated when ordering from the followings <ul style="list-style-type: none"> Relay contact 1a Resistive load: 3A (250Vac), Inductive load: 1A (250Vac, cos φ=0.4) Non-contact voltage For SSR drive 12⁺/₀ Vdc (40mA max.) Current 4-20mA_{dc} (Isolated type) Load resistance: 550Ω max.
Alarm 1	Output action Select the action by A1 rotary switch Standby function can be designated. <ul style="list-style-type: none"> No function [FCS-100 type] [FCS-200 type] High limit action (Deviation setting) Setting range: ±200°C (°F) ±Input range span (OFF when set to 0) Low limit action (Deviation setting) Setting range: ±200°C (°F) ±Input range span (OFF when set to 0) High/Low limits action (Deviation setting) Setting range: 0 to 200°C (°F) 0 to Input range span (OFF when set to 0) High/Low limit range action (Deviation setting) Setting range: 0 to 200°C (°F) 0 to Input range span (OFF when set to 0) Process value high limit action Setting range: Scale range Input range minimum to maximum value Process value low limit action Setting range: Scale range Input range minimum to maximum value Setting accuracy The same as the accuracy of PV input indication Control action ON/OFF action Hysteresis 0.1 to 100.0°C (°F) Control output Relay contact 1a Resistive load: 3A (250Vac), Inductive load: 1A (250Vac, cos φ=0.4)
Supply voltage	To be designated when ordering from the followings <ul style="list-style-type: none"> 100 to 240Vac 50/60Hz Allowable voltage fluctuation: 85 to 264Vac 24Vac/dc (Duplex use) Allowable voltage fluctuation: 20 to 28Vac/dc
Power consumption	Approx. 8VA (maximum)
Instantaneous power failure	Within 30ms Data keeping: Non-volatile memory
Insulation, Dielectric strength	Insulation resistance 10MΩ or greater when applying 500Vdc to the terminals (except between non-insulated terminals) Dielectric strength Between Input terminal and Ground terminal/Power terminal, 1.5kVac for 1 min Between Power terminal and Ground terminal, 1.5kVac for 1 min Between Output terminal and Ground terminal/Power terminal, 1.5kVac for 1 min
Environment	Ambient temperature: 0 to 50°C, Ambient humidity: 35 to 85%RH (non-condensing)
Size · Weight	Size: Refer to "External dimension (page 13)", Weight: approx. 140 g
Material · Color	Material: Flame resistance resin Color: Light gray or Black (black: option)
Mounting method	Flush To be fixed with one-touch mounting bracket, or screw type mounting bracket (option)
Setting system	Key-input system
Attached function	Refer to the pages 6 to 7.
Accessories	1 set of mounting bracket, 1 copy of instruction manual

■ Sold separately

● Front cover (soft type)

Soft type front cover for dust-proof-drip-proof, and front key operations can be performed on the cover. When ordering, select the cover size to meet the type.

- For 96×96mm Model: FC-96-S
- For 48×96mm Model: FC-R-S
- For 48×48mm Model: FC-48-S

● Communication converter

It is a Communication interface converter for serial communication [option]. It relays the data between the host computer and FC series controllers.

IF-100-C5

External dimension: 64×194×107 (W×H×D)
Mounting method: Wall surface mounting
Transfer rate: 1200/2400/4800/9600bps

IF-300-C5

External dimension: 49×80×132 (W×H×D)
Mounting method: DIN rail mounting
Transfer rate: 2400/4800/9600/19200bps



● Setting value memory number changing switch

● Others

Various equipments related to the control are provided. Make inquiry.

- Thermocouple, Compensating lead wire for thermocouple
- RTD
- Infrared radiation temperature sensor
- Humidity or Hygrothermo sensor
- Other sensors
- Electromagnetic relay, SSR, Power controller
- Recorder
- Timer, PLC, Touch panel type monitor
- Computer software for communication (when ordered)
- Others

Glossary

Process controller Such value as Temperature, Humidity, Flow rate or Pressure of the process for production is input to the controller in analog signal. The controller automatically operates the output manipulating value (MV) so that the process value (PV) can accord with the setting value (SV) set in advance, and outputs the value. The FC series is a Process controller providing quick response performance.

PID control system P action suppresses the overshoot and hunting, I action corrects the offset, and D action stabilizes the temperature change caused by disturbance. With this FC series, the PID parameters can be set automatically.

Proportional cycle With the controllers Relay contact output type or Non-contact voltage output type, it can output only ON signal and OFF signal, however, it can perform the PID control by time-division system to meet the output ON time to the MV. The cycle repeating the output ON and OFF is the Proportional cycle.

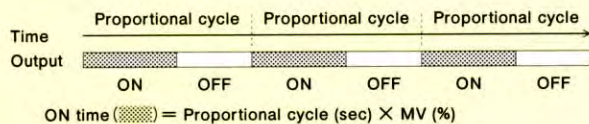

Relay contact output Control output system to make the load input such as heater ON or OFF by closing or opening the relay contact. Built-in relay of the FC series withstands 3A × 300000 times of load, however, it is recommended that the external relay be provided even if using the load capacity 3A or less since the life may be shortened by rush current. If setting the proportional cycle shorter (less than 10 seconds), it causes the relay degradation faster. (Factory adjusted as 30 seconds)

Non-contact voltage output Control output system to make the SSR (non-contact relay) ON or OFF by the DC voltage signal ON or OFF. Short proportional cycle is available to the control output. (Factory adjusted as 3 seconds)

Current output Control output system to output 4 to 20mA dc of analog signal correspond to 0 to 100% of the MV.

ON/OFF servo output Control output system to control the control valve by using the relays for open output and closed output. The FC series has the function to operate the control valve flow rate and therefore the flow rate feedback by feedback potentiometer is not required.

※The contents of this catalog is as of September 2001. Specifications subject to change without notice.
※For any inquiry of this controller, please contact your shop where purchased or our agency.

SHINKO TECHNOS CO., LTD. OVERSEAS DIVISION

Reg. Office : 2-48, 1-Chome, Ina, Minoo, Osaka, 562-0015, Japan
Mail Address: P. O. Box 17, Minoo, Osaka, Japan
Tel : 81 - 727 - 21 - 2781
Fax : 81 - 727 - 24 - 1760
URL : <http://www.shinko-technos.co.jp>
E-mail : overseas@shinko-technos.co.jp